



# DW General Wood Machinists Ltd

855-863 High Road, Tottenham, London N17 8EY

Tel: 020 8801 1127

Fax: 020 8808 1215

## Skirting & Architrave Profiles in Various Widths

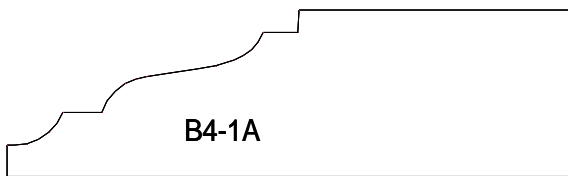

B4-1A



B2-2A

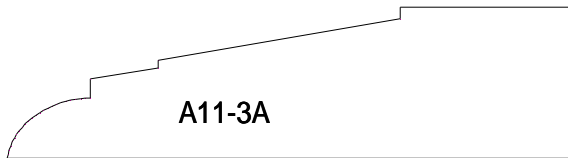

A11-3A

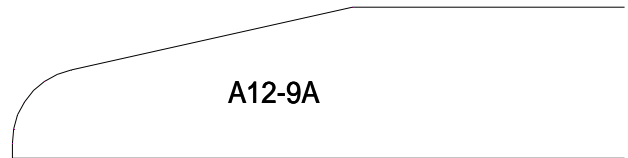

A12-9A

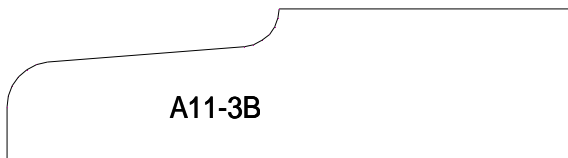

A11-3B

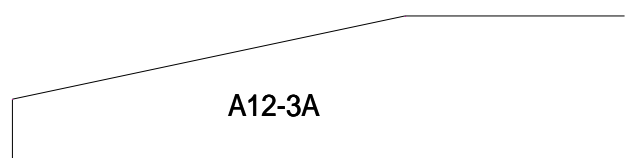

A12-3A

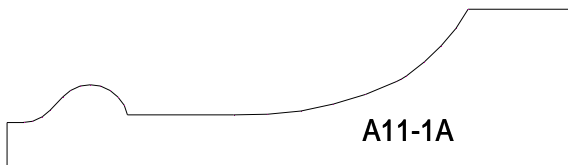

A11-1A

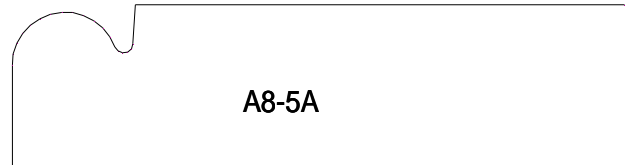

A8-5A

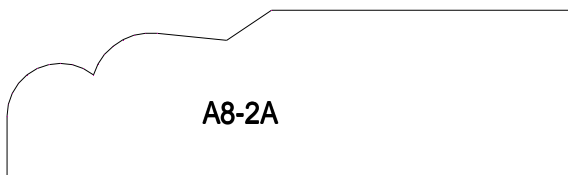

A8-2A

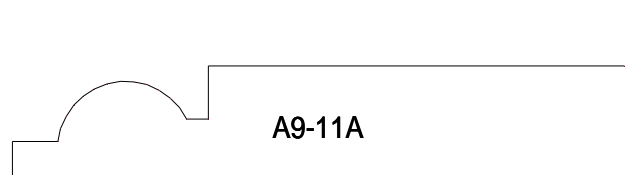

A9-11A

## Specialist & Reproduction Mouldings Made to Order

50mm



Skirting & Architraves Page 1

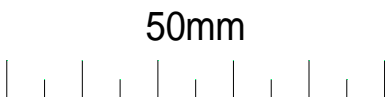
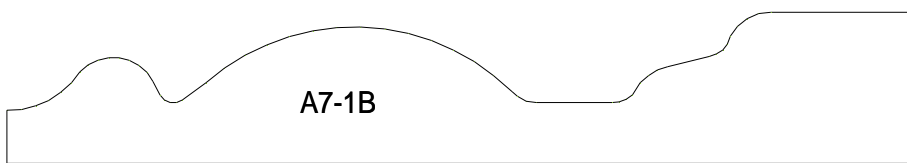
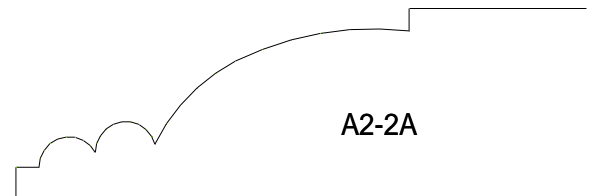
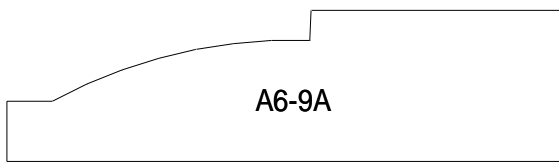
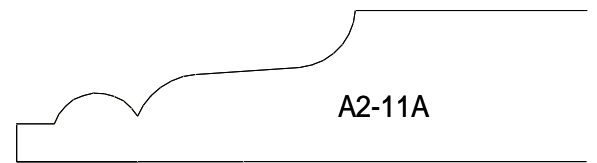
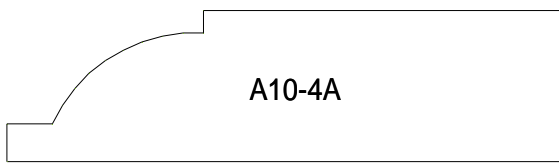
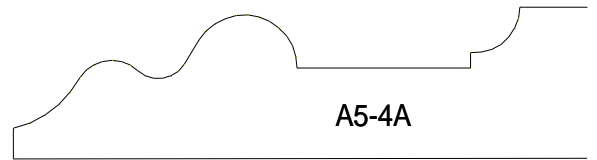
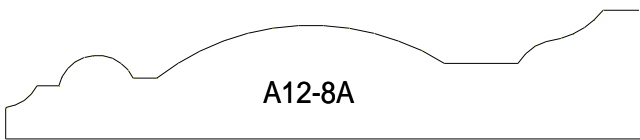
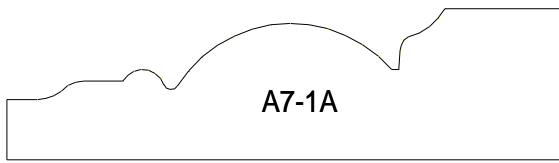
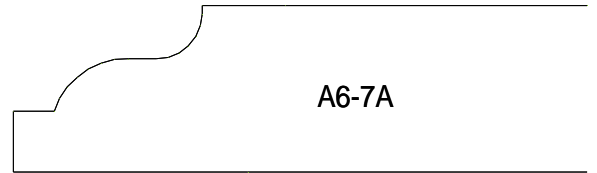
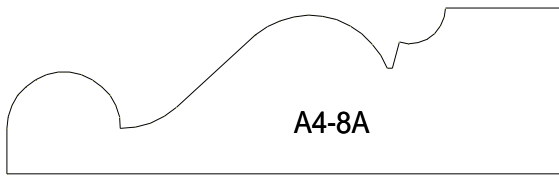
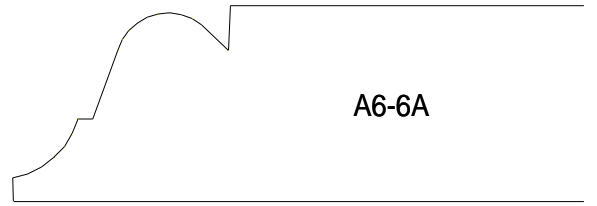
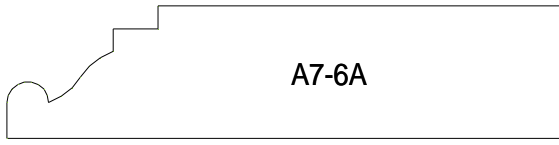
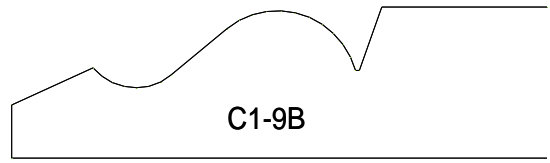
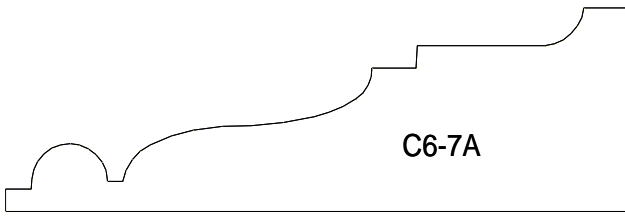

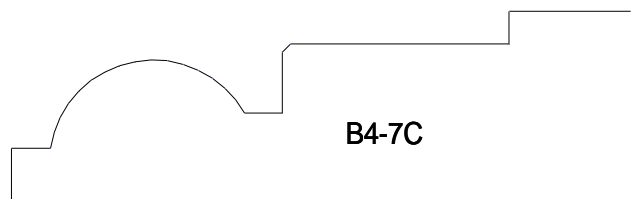
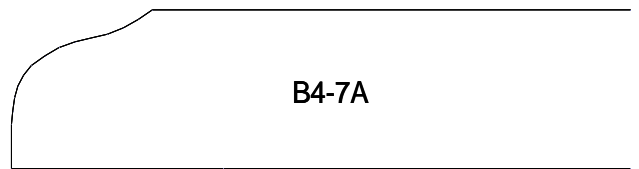
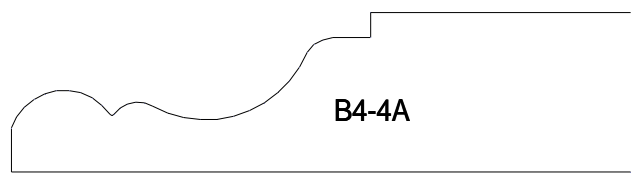
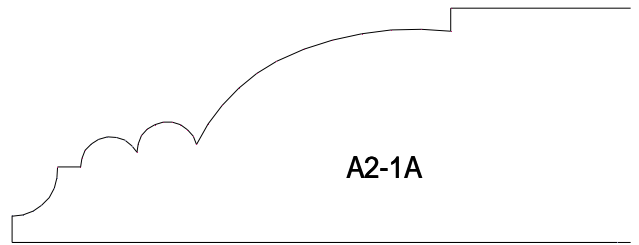
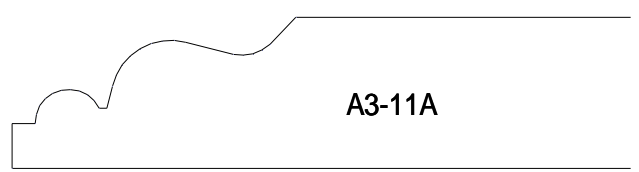
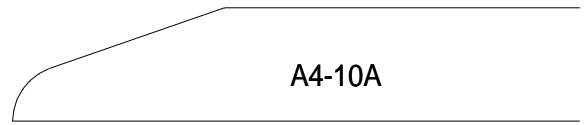
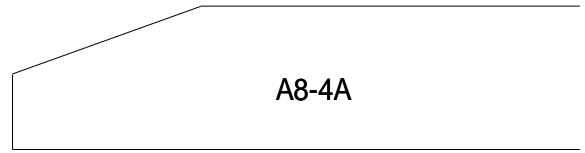
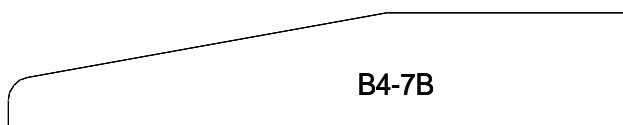
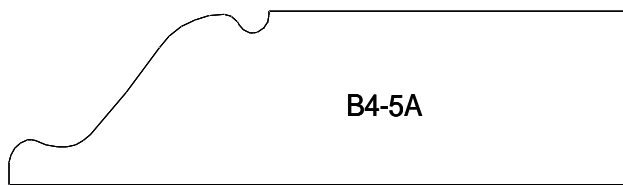
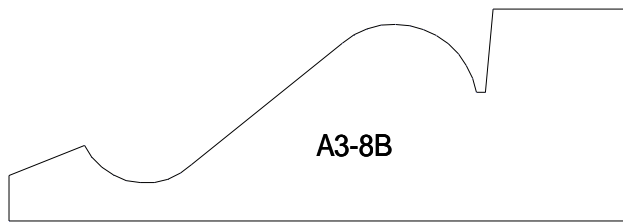
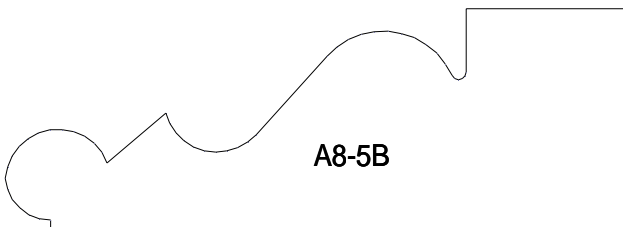
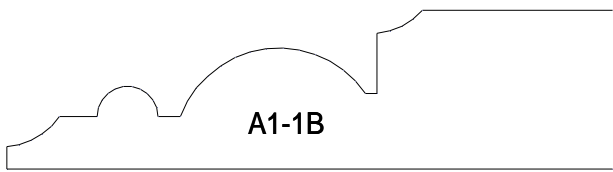
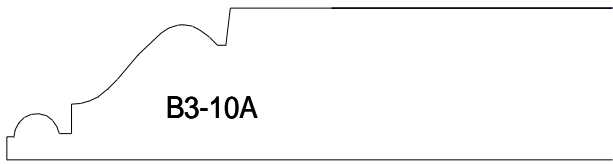
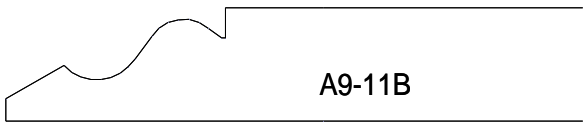
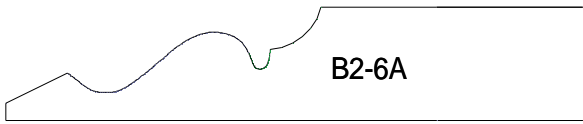

50mm



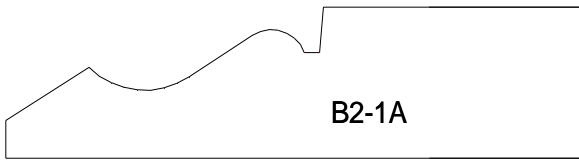

B2-1A

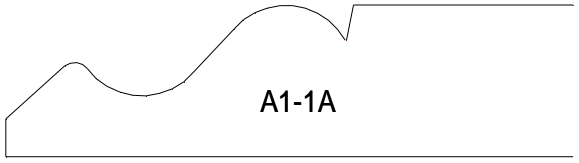

A1-1A

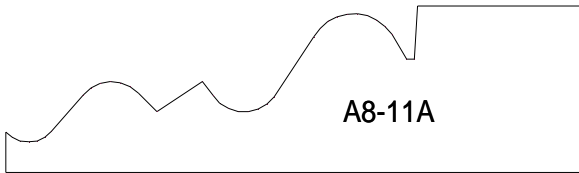

A8-11A

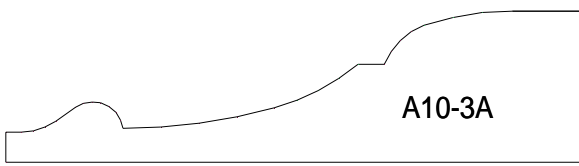

A10-3A



A5-6B

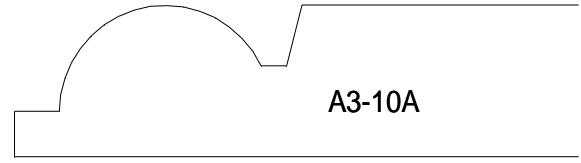

A3-10A

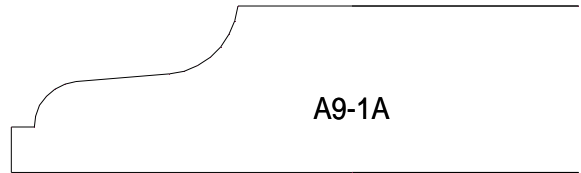

A9-1A

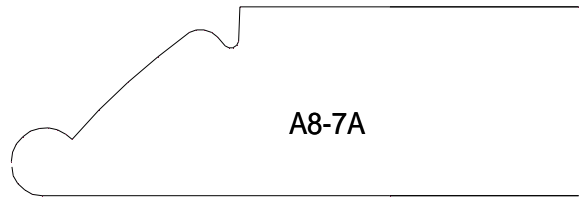

A8-7A

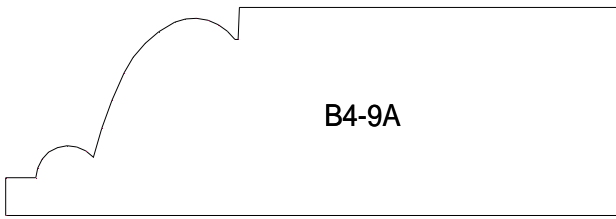

B4-9A

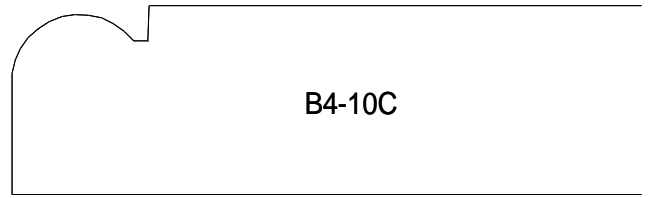

B4-10C

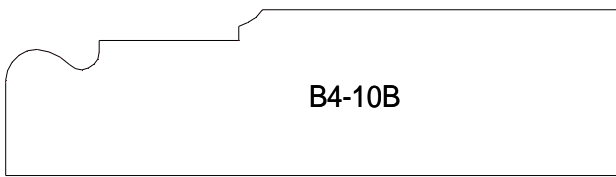

B4-10B

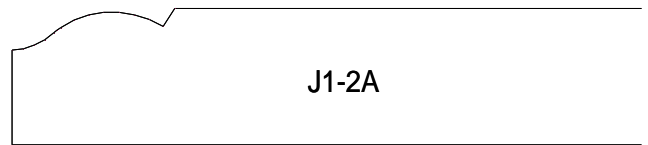

J1-2A

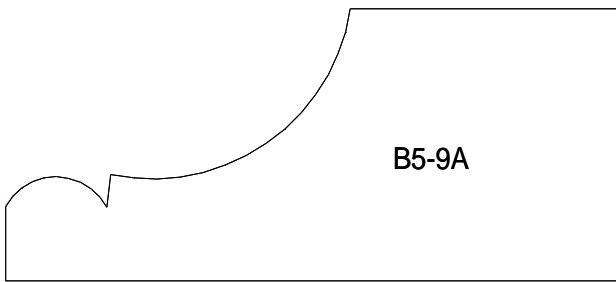

B5-9A



B5-10B

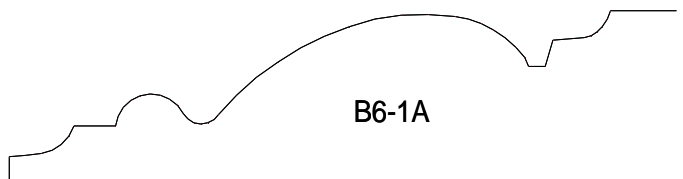

B6-1A

50mm



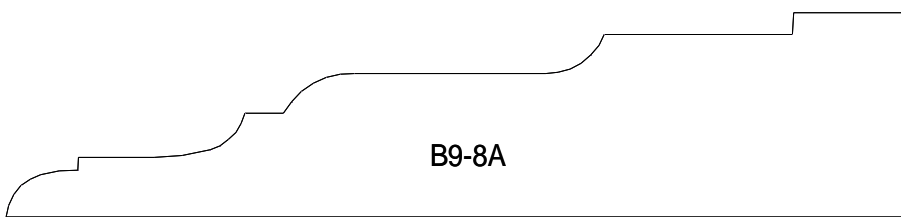
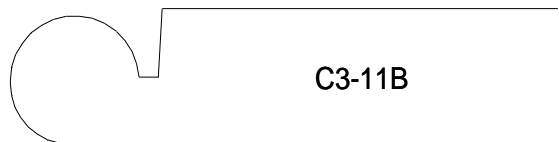
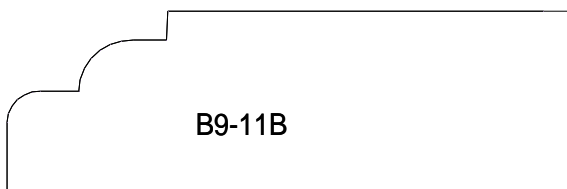
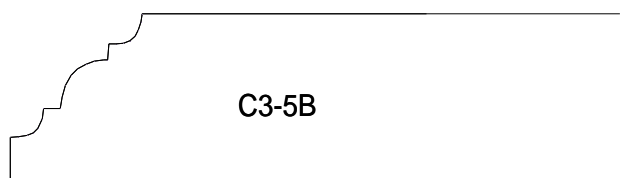
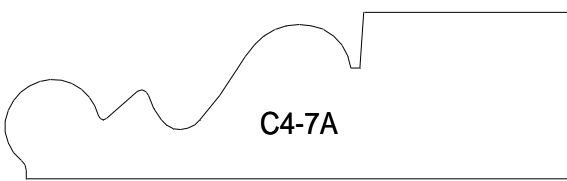
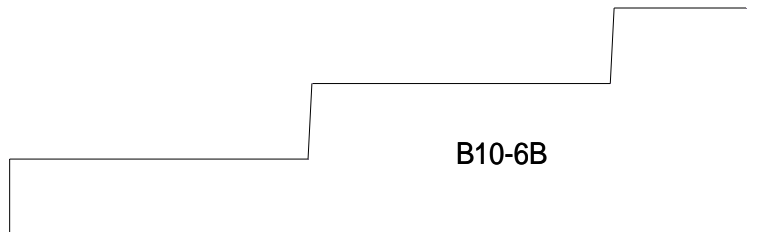
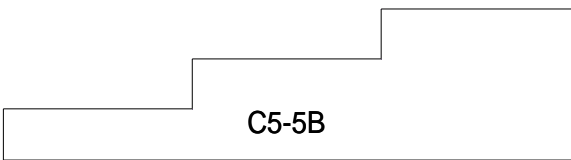
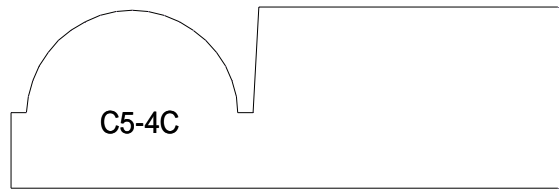
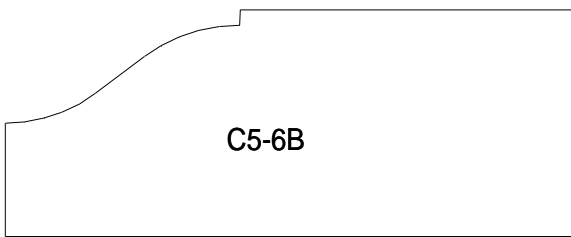
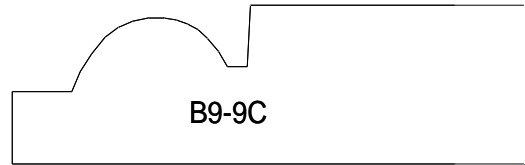
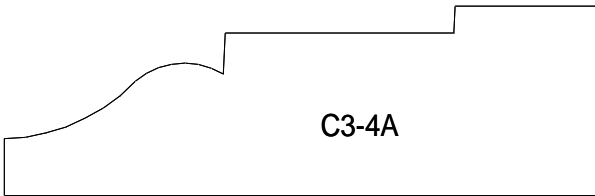
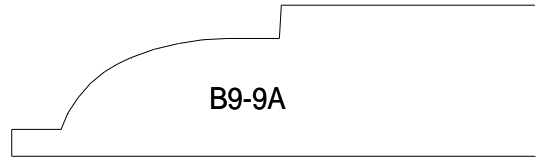
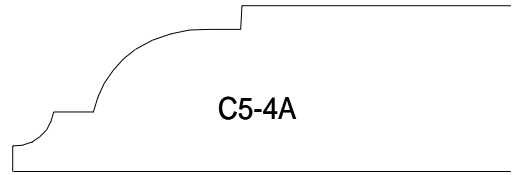
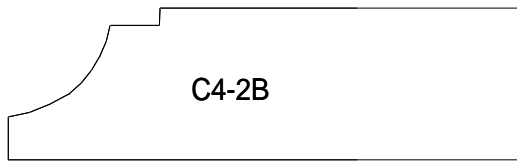

50mm



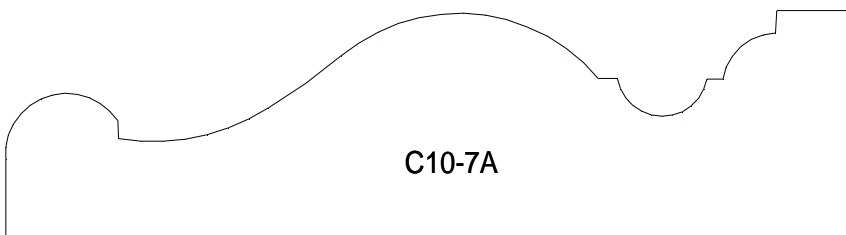
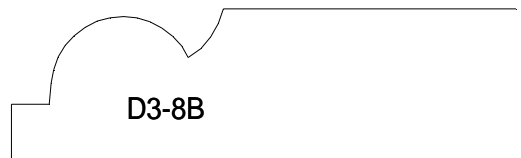
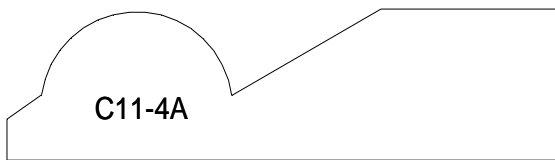
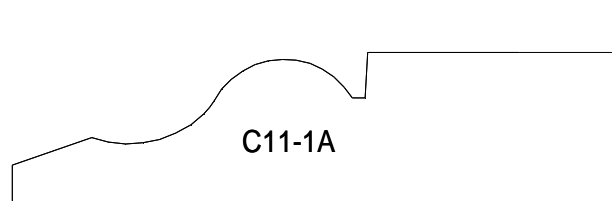
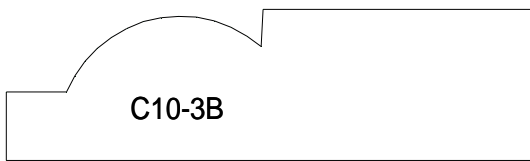
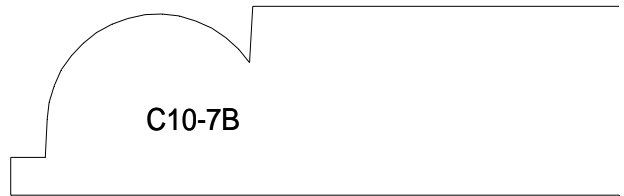
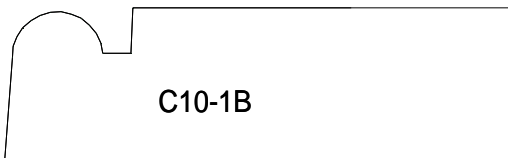
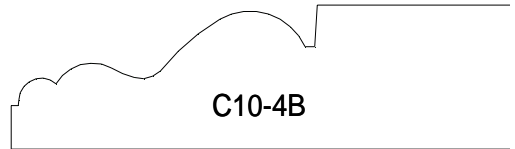
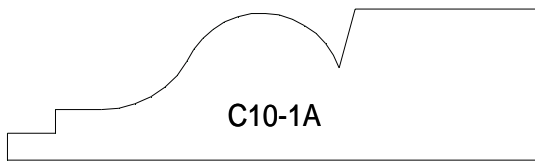
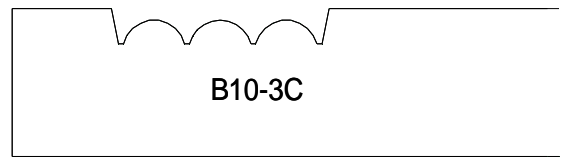
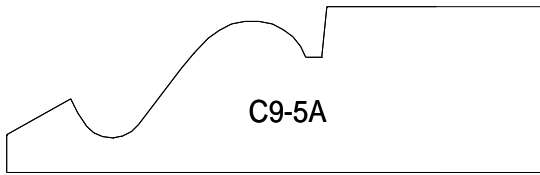
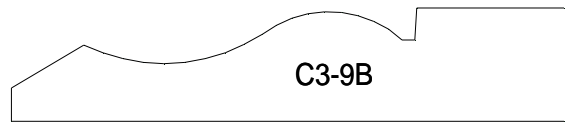
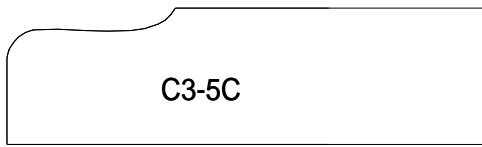

50mm



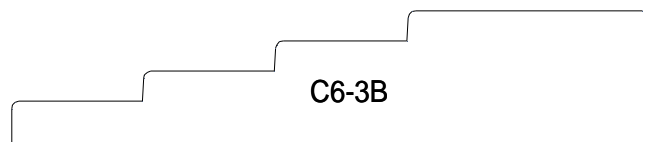
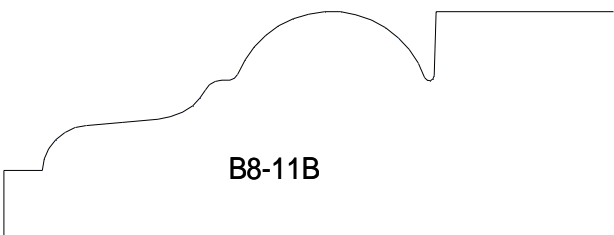
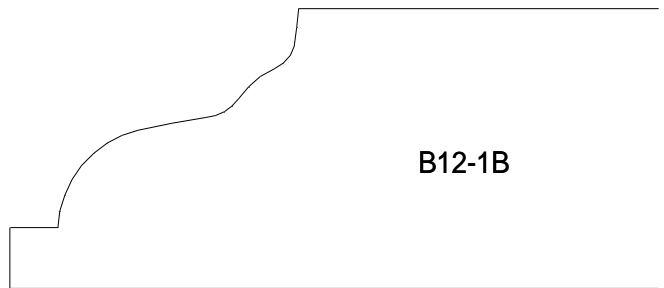
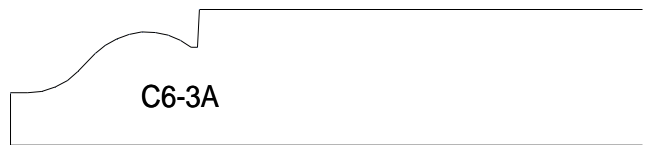
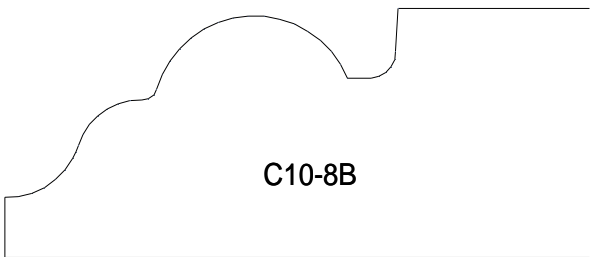
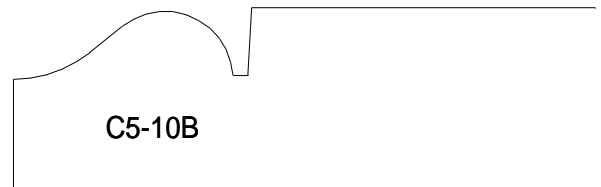
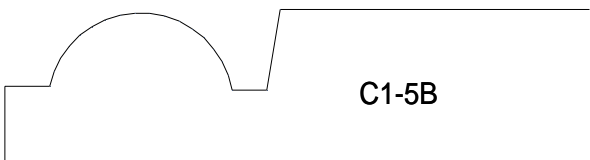
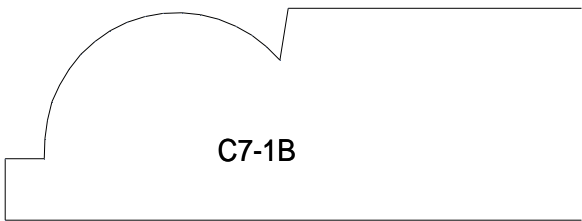
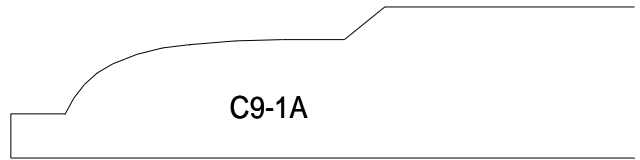
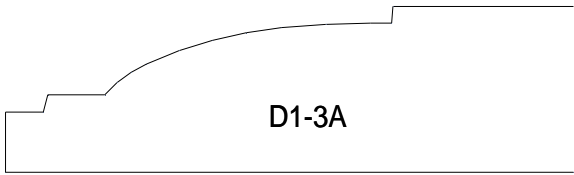

50mm



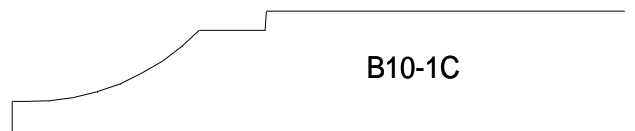
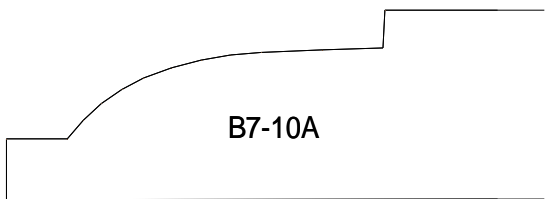
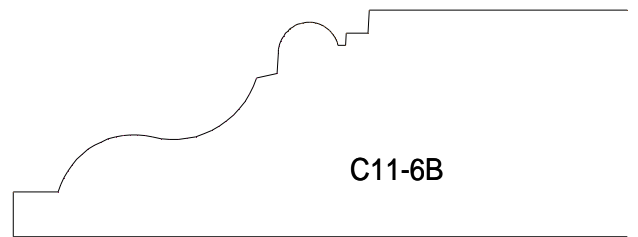
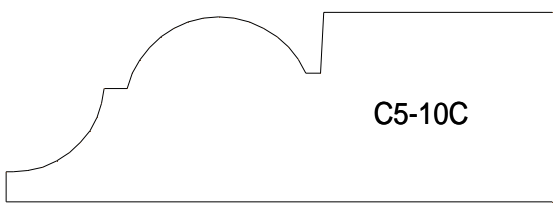
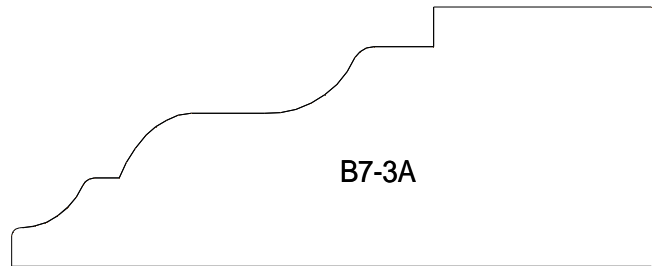
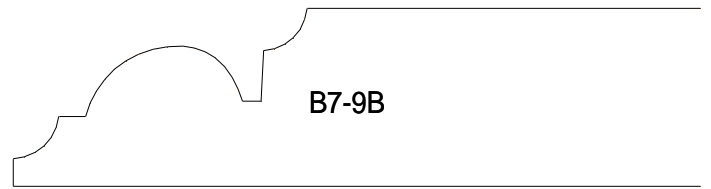
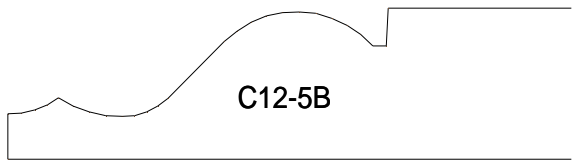
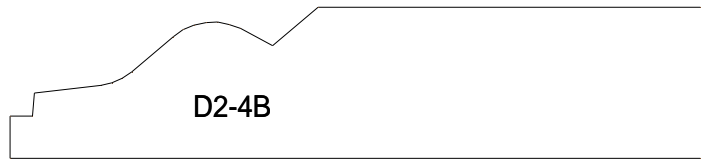
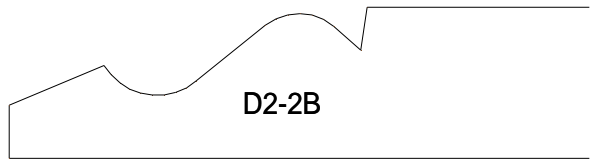
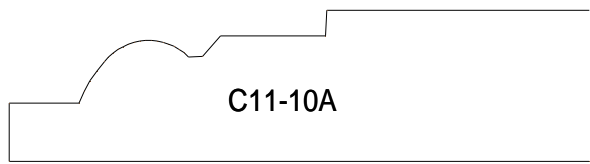
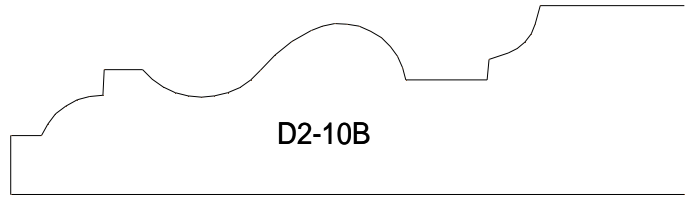
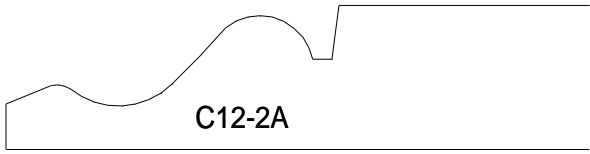
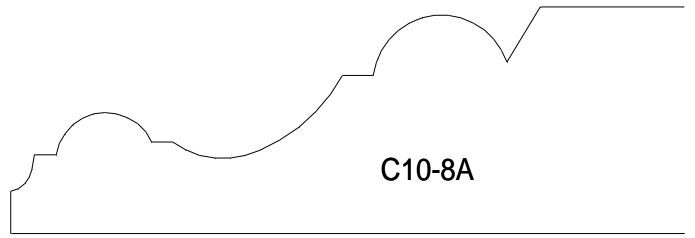
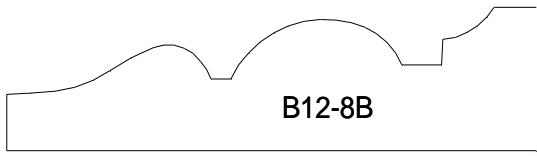

50mm



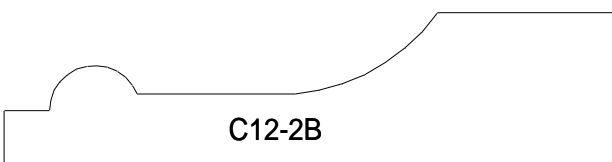
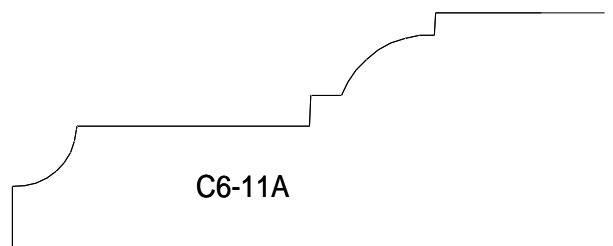
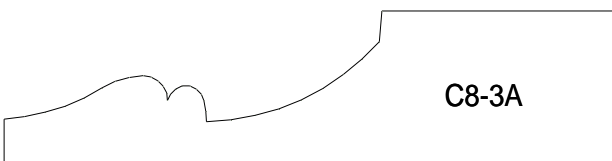
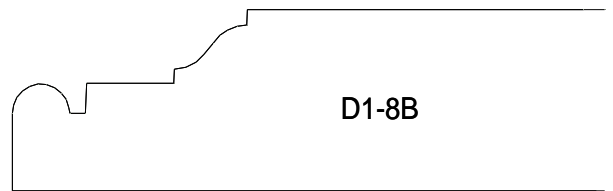
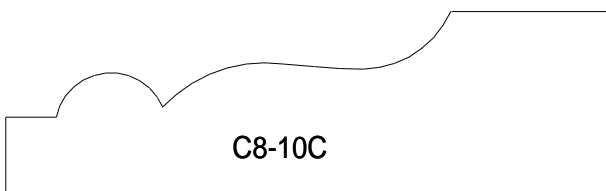
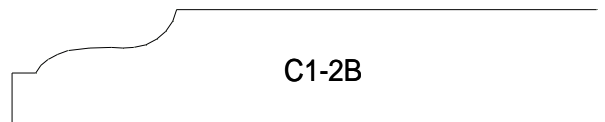
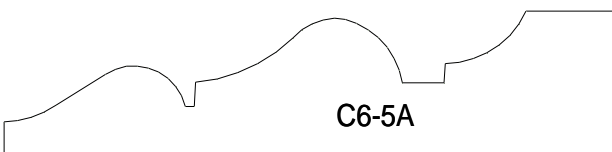
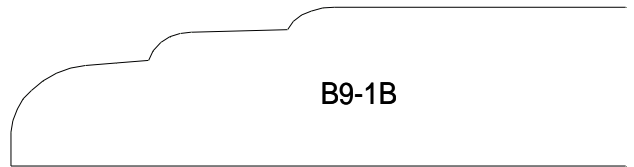
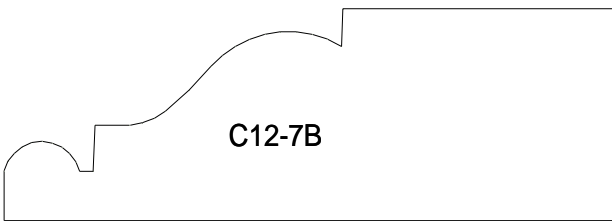
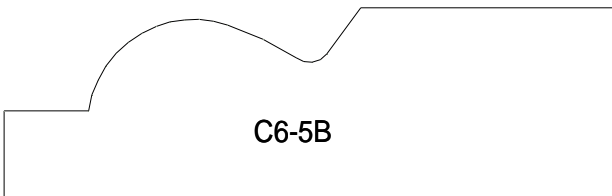
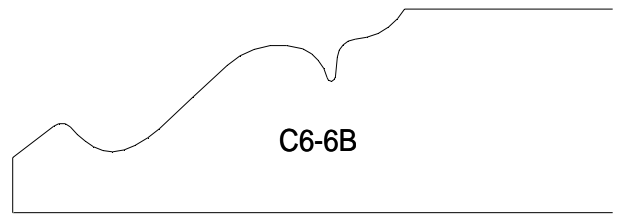
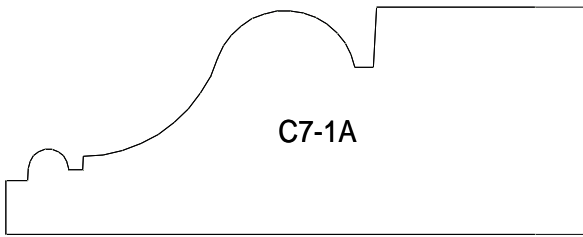
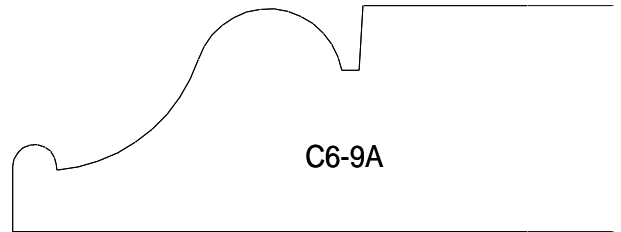
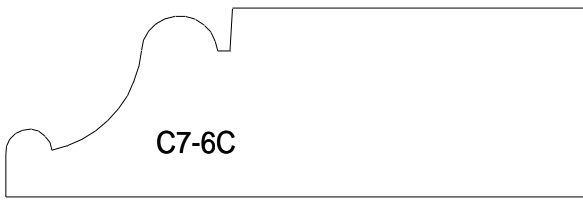

50mm



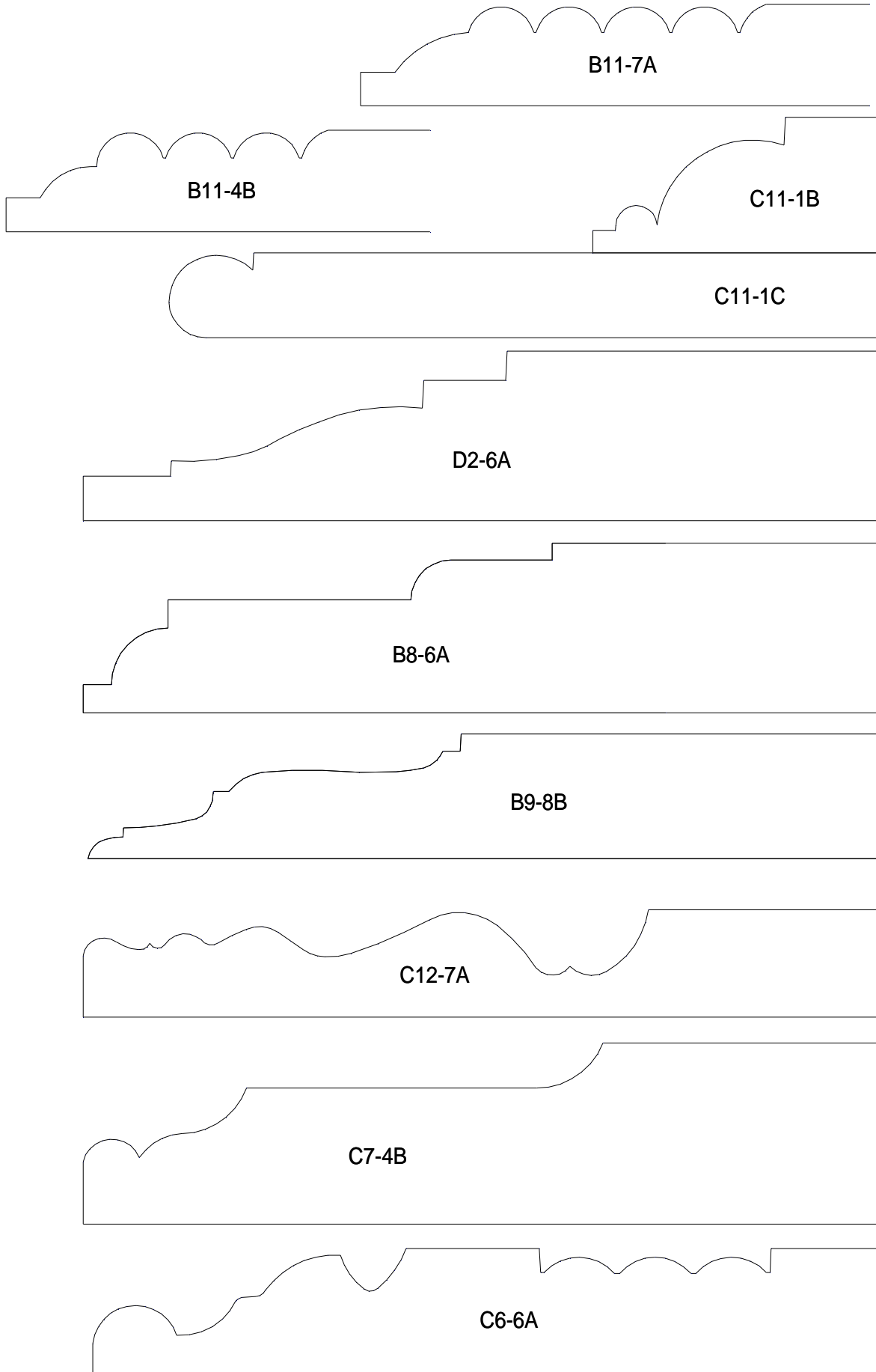

50mm



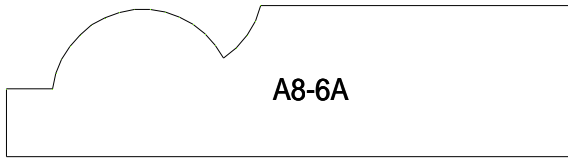

A8-6A

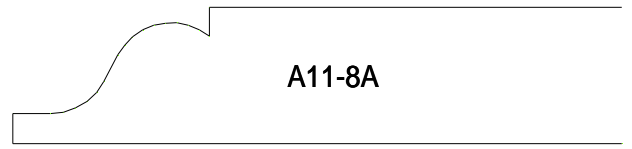

A11-8A



B11-6B

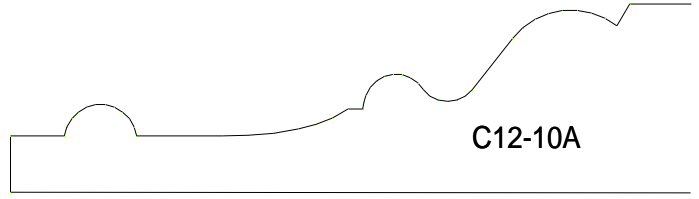

C12-10A

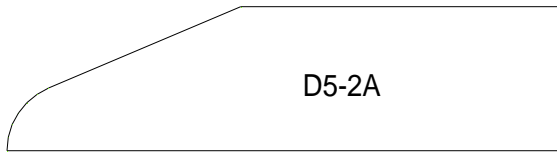

D5-2A



D5-3A



D5-4A



D5-4B



D5-6B

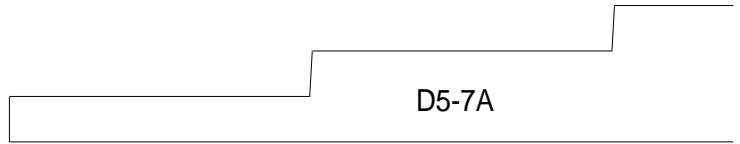

D5-7A

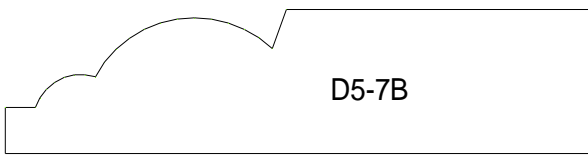

D5-7B

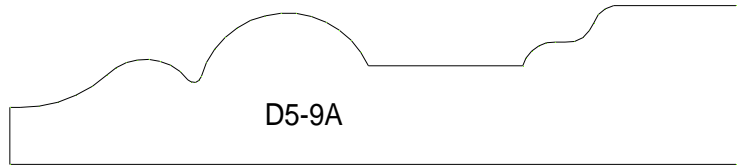

D5-9A

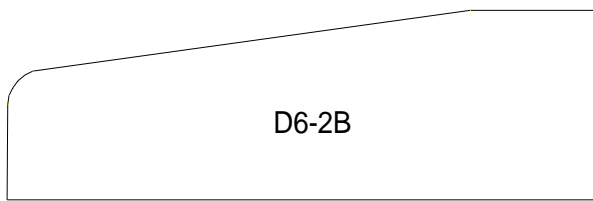

D6-2B

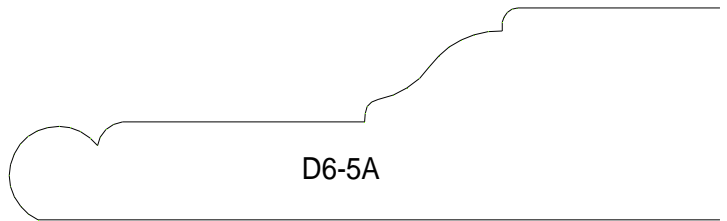

D6-5A



D6-7B

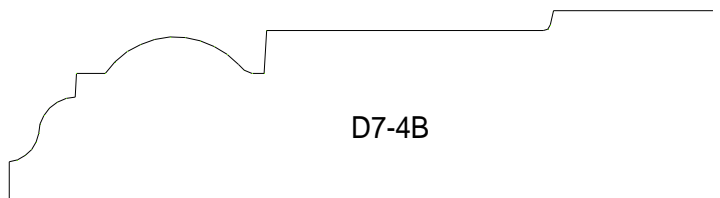

D7-4B

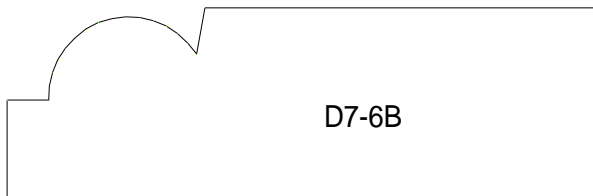

D7-6B

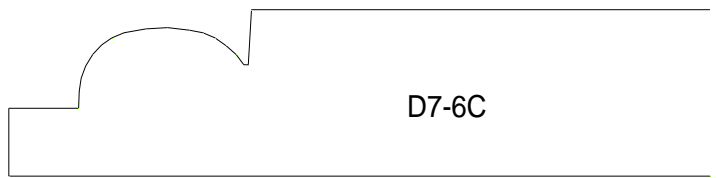

D7-6C

50mm



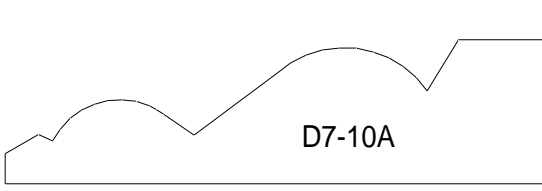

D7-10A



D7-9B

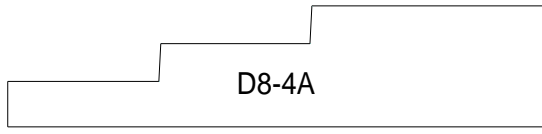

D8-4A

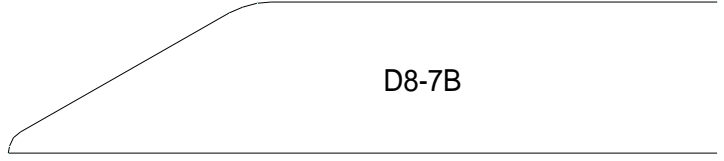

D8-7B

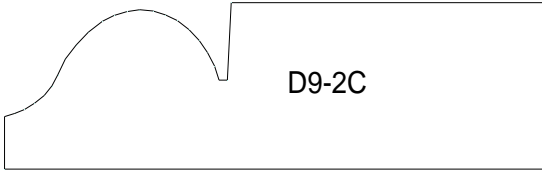

D9-2C



D9-5A

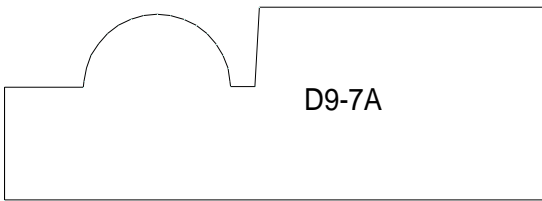

D9-7A

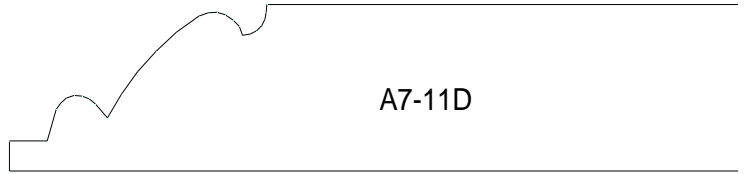

A7-11D

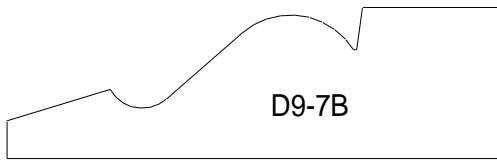

D9-7B

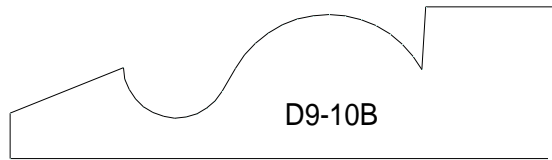

D9-10B

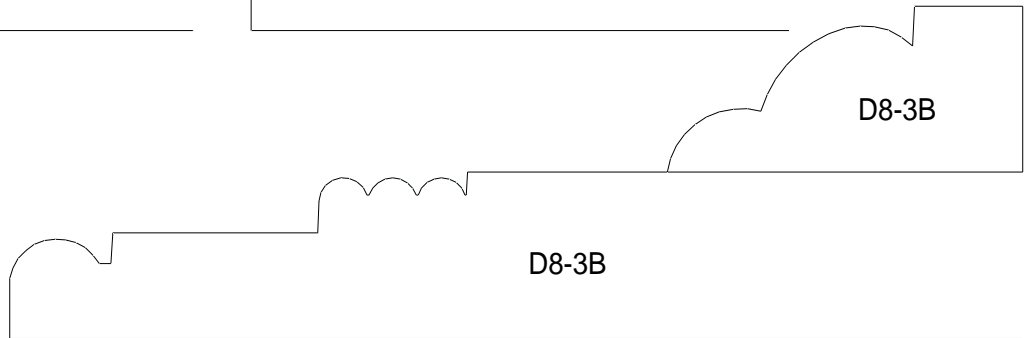

D8-3B

D8-3B

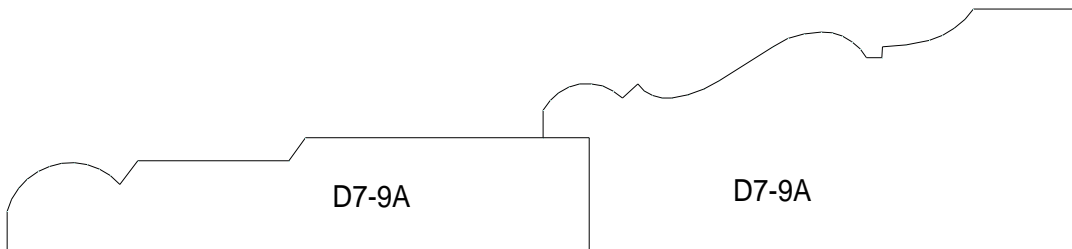

D7-9A

D7-9A

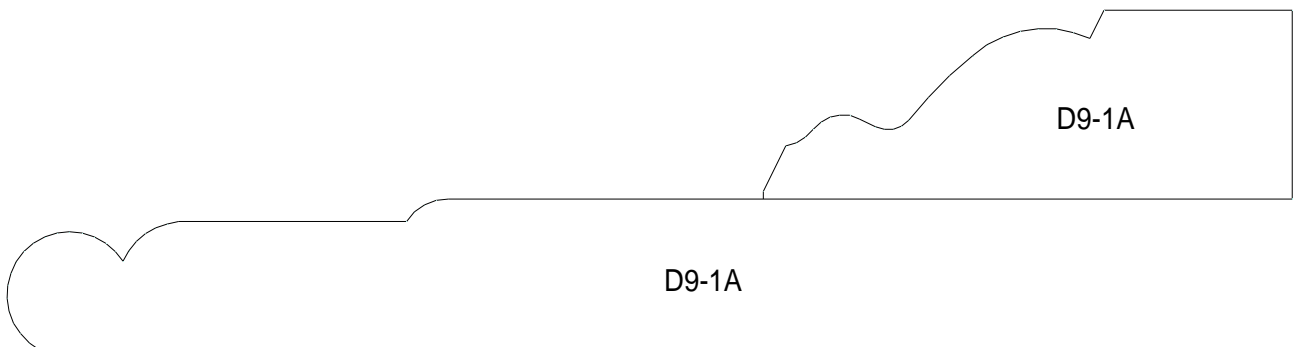

D9-1A

D9-1A

50mm



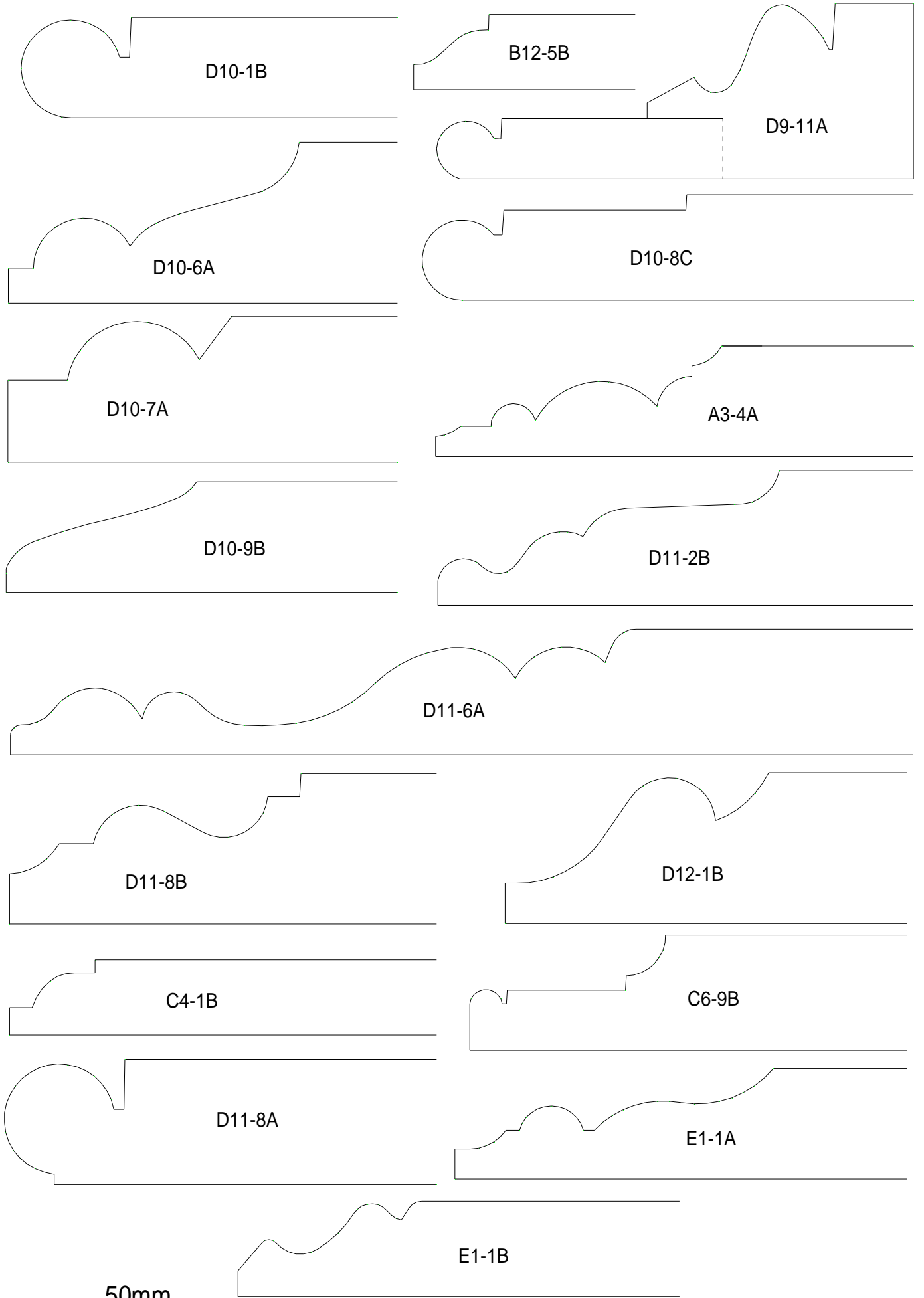

50mm



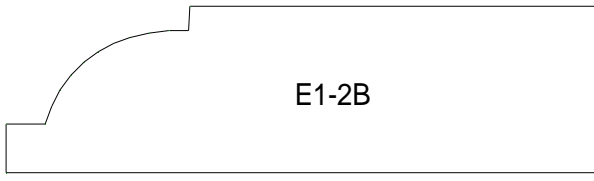

E1-2B

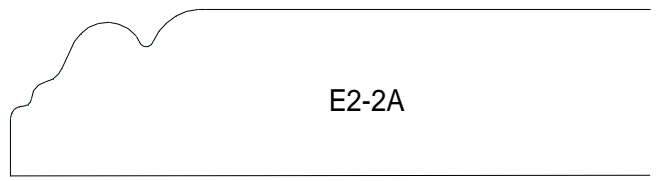

E2-2A

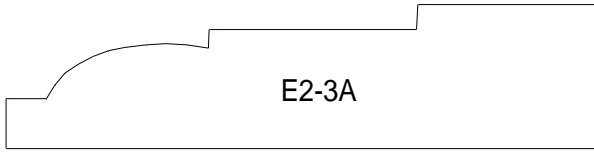

E2-3A

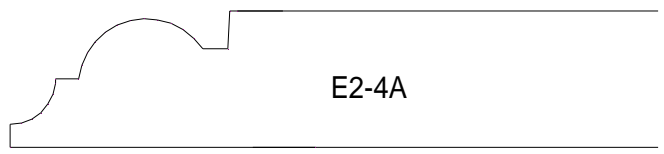

E2-4A

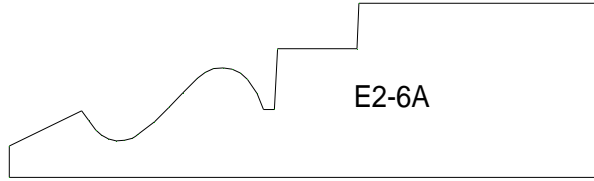

E2-6A

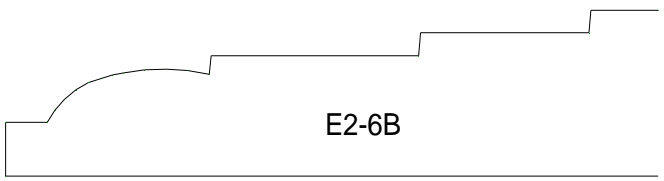

E2-6B



E2-8A

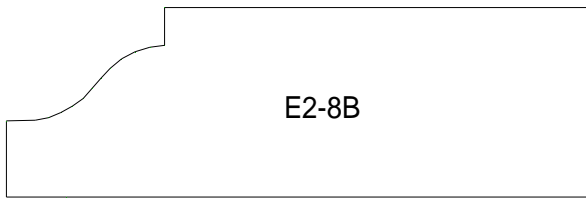

E2-8B

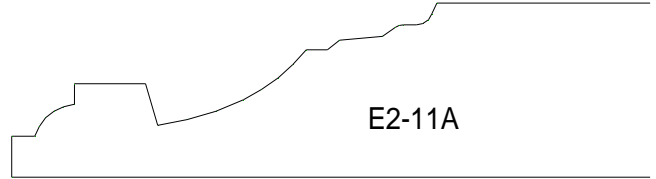

E2-11A

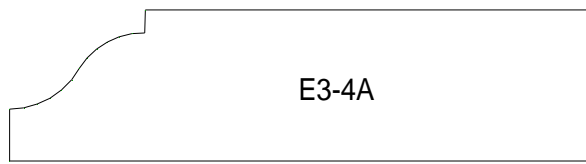

E3-4A

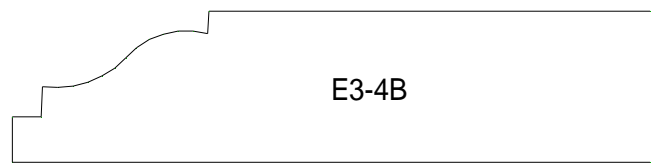

E3-4B

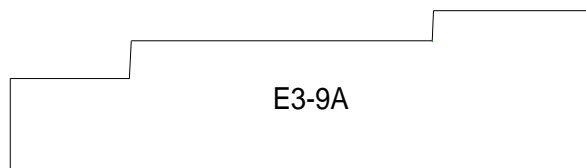

E3-9A

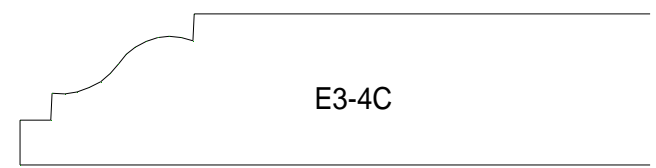

E3-4C

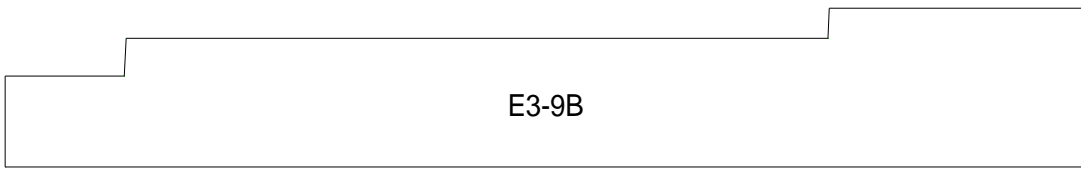

E3-9B

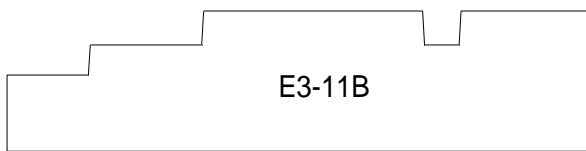

E3-11B

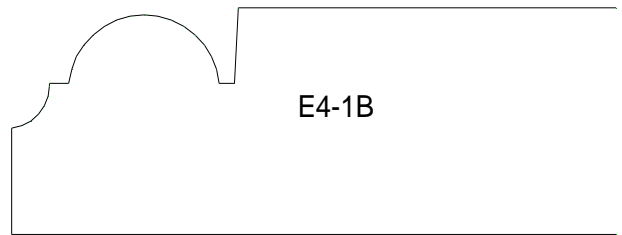

E4-1B

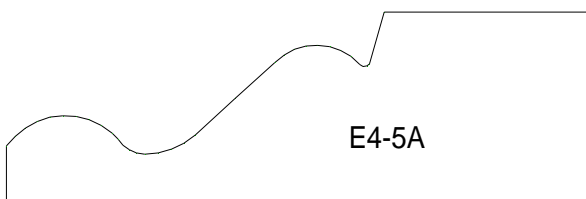

E4-5A

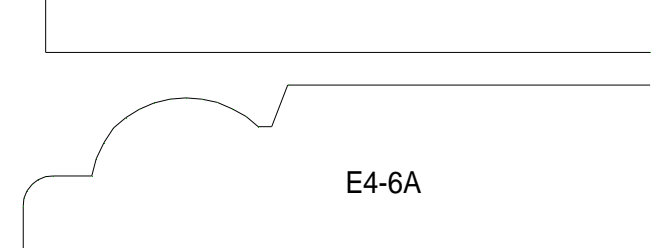

E4-6A

50mm



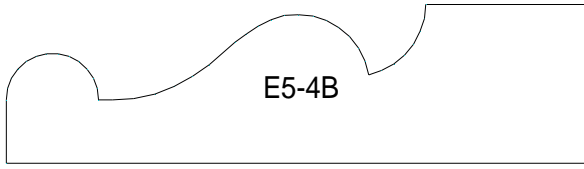

E5-4B

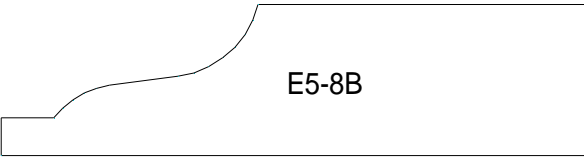

E5-8B

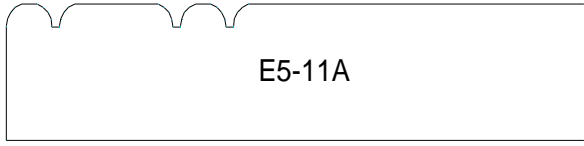

E5-11A

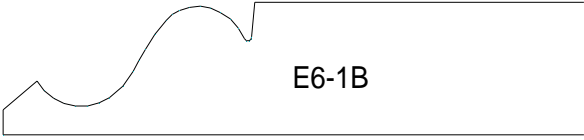

E6-1B

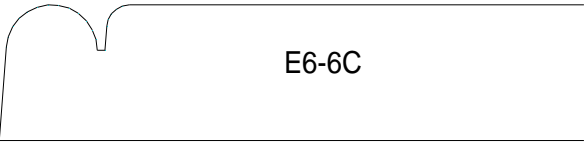

E6-6C

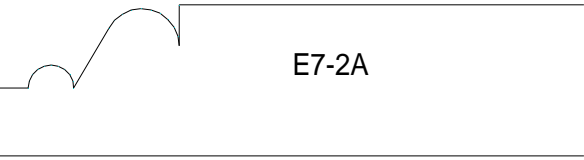

E7-2A

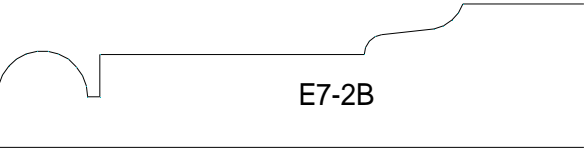

E7-2B

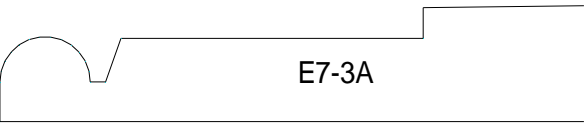

E7-3A



E8-2B

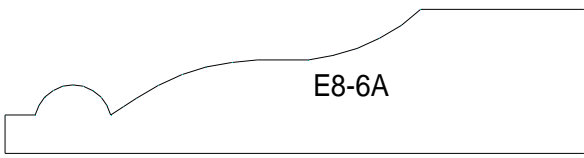

E8-6A

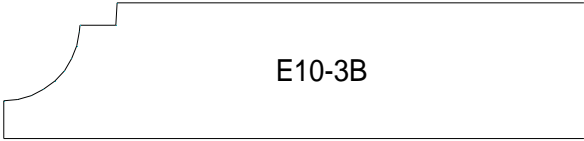

E10-3B

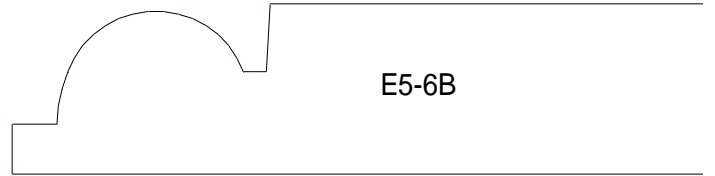

E5-6B

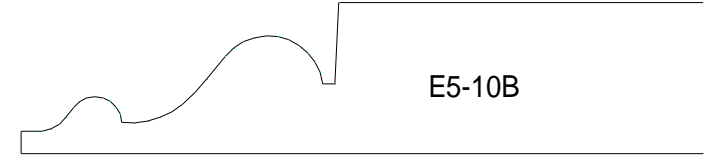

E5-10B

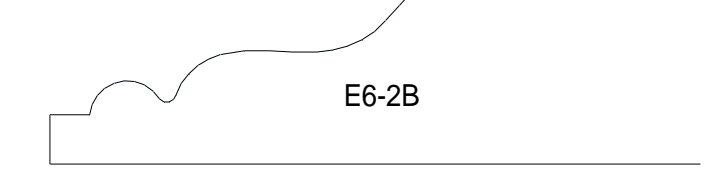

E6-2B

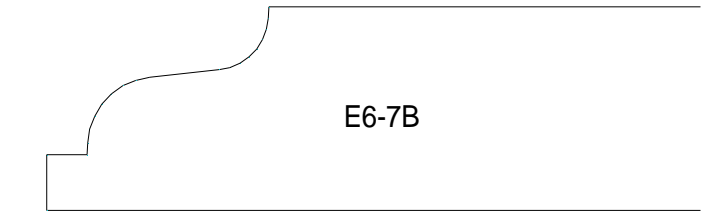

E6-7B

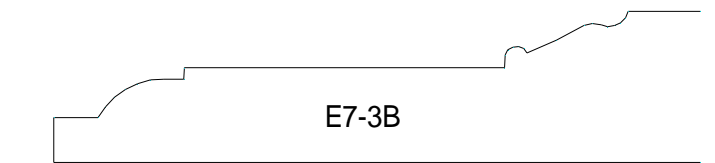

E7-3B

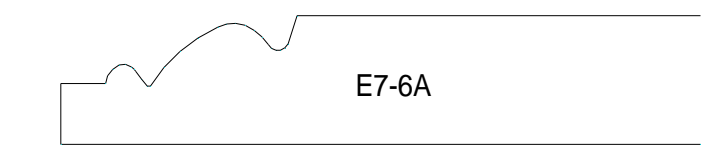

E7-6A

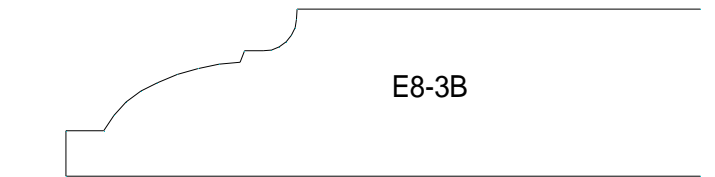

E8-3B

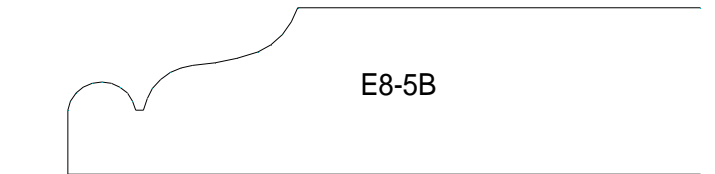

E8-5B



E8-10B

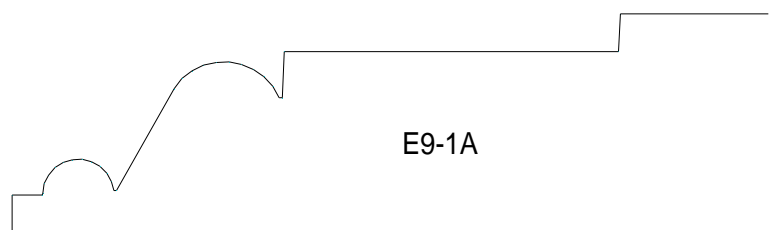

E9-1A

50mm



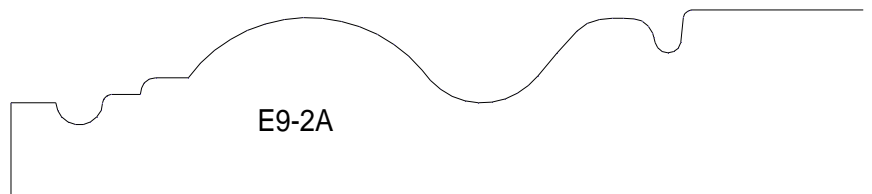
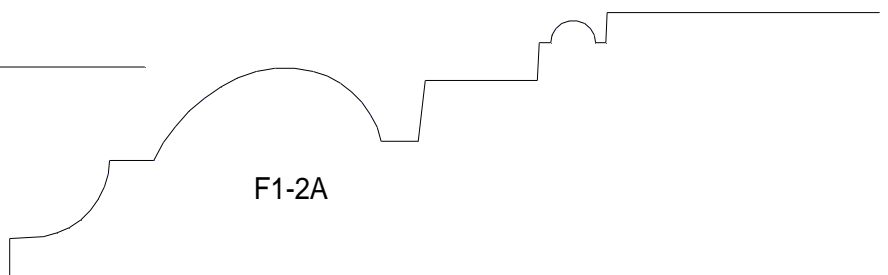
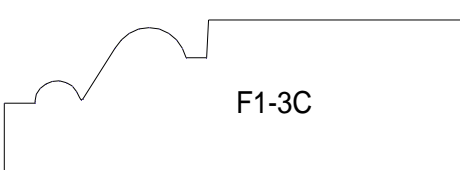
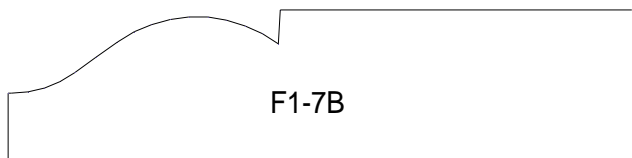
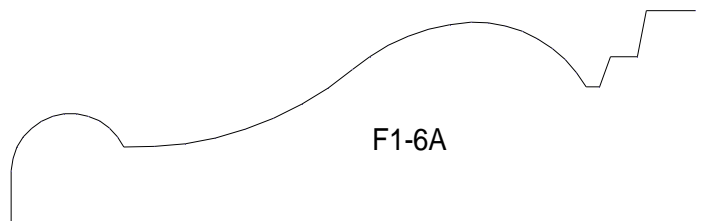
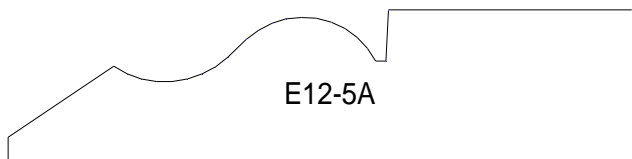
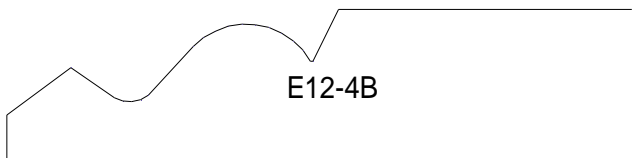
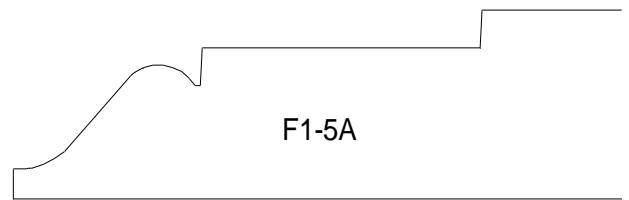
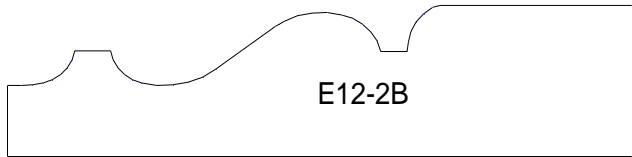
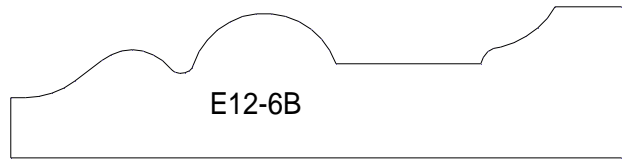
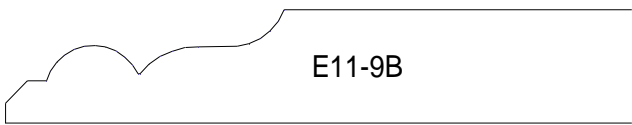
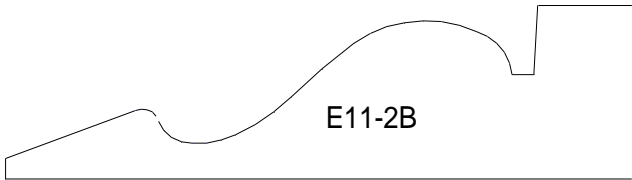
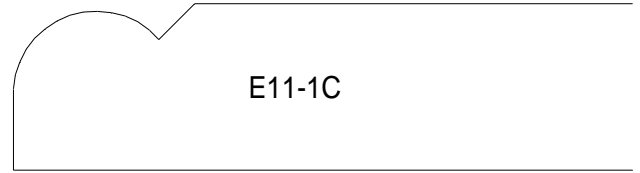
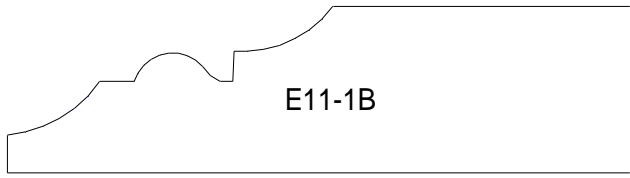
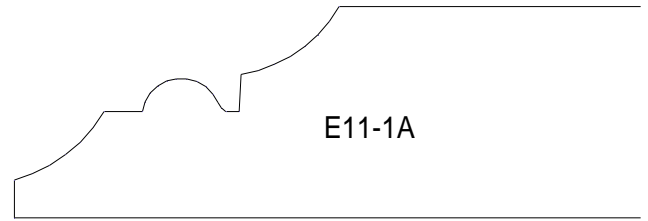
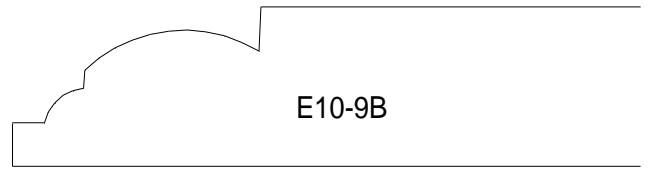
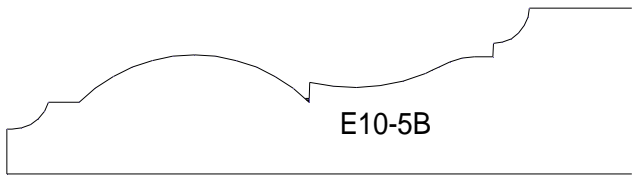

50mm





F1-9B

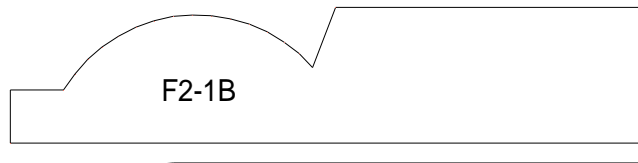

F2-1B

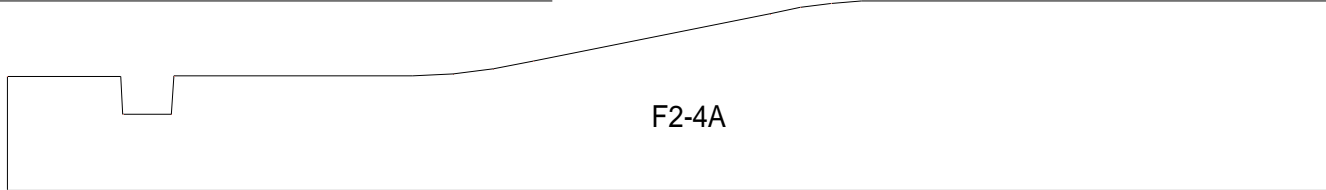

F2-4A

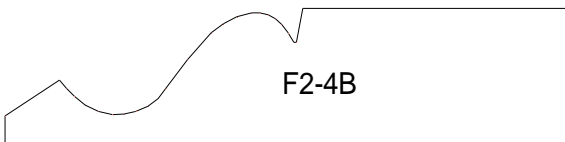

F2-4B



F2-3B



F3-2A

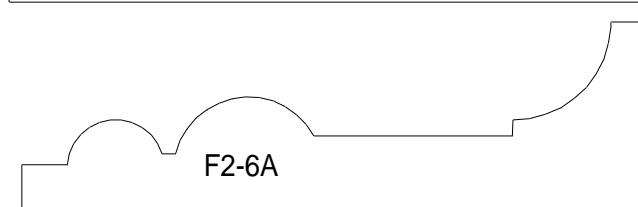

F2-6A

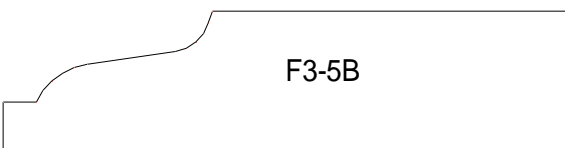

F3-5B

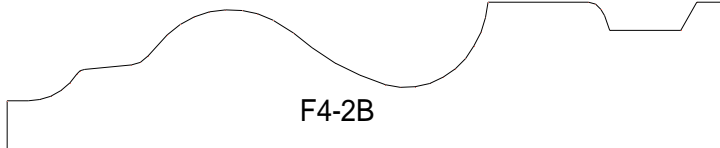

F4-2B

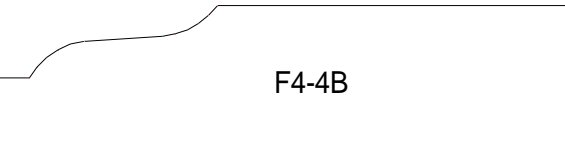

F4-4B

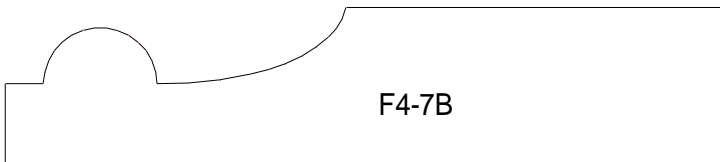

F4-7B



F4-6B

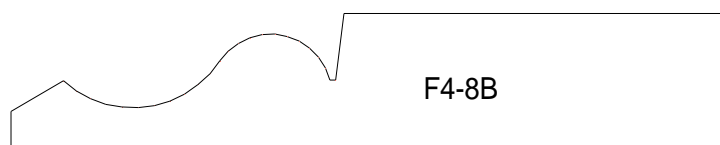

F4-8B

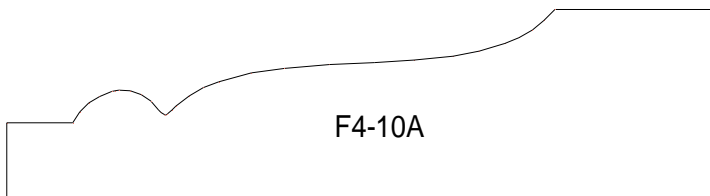

F4-10A

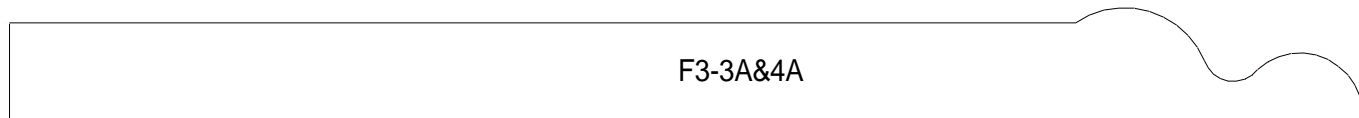

F3-3A&4A

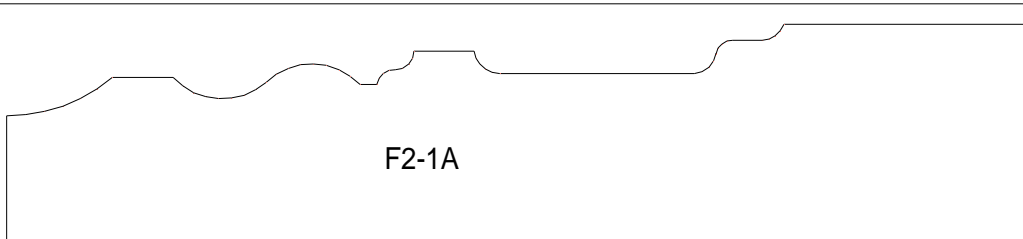

F2-1A

50mm



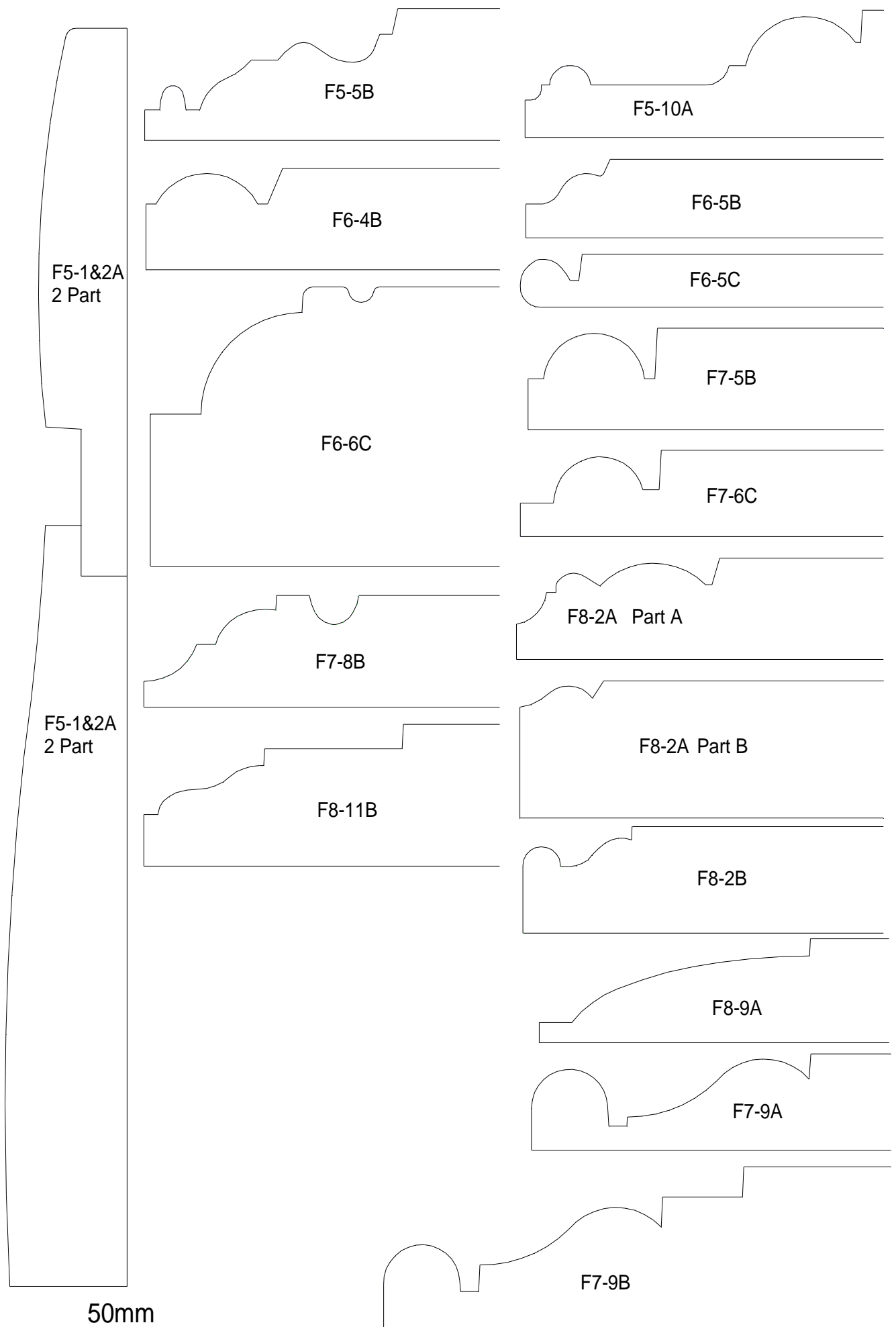

# Top Sections for 2 Part Skirting

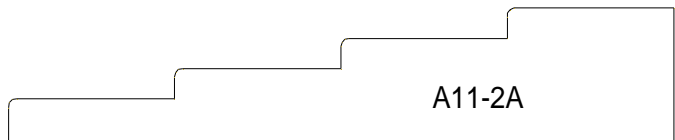
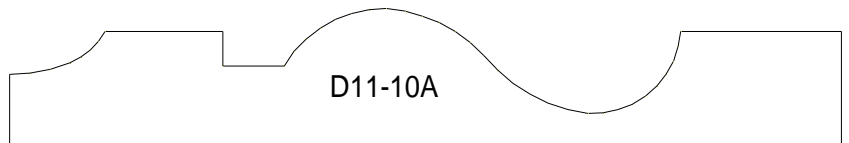
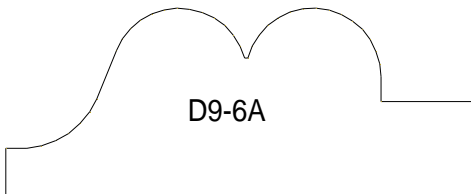
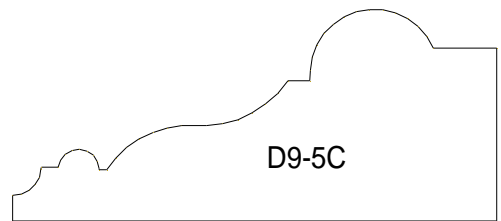
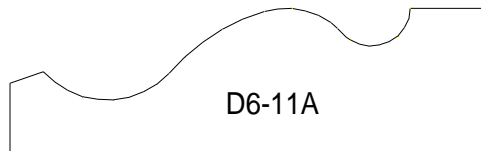
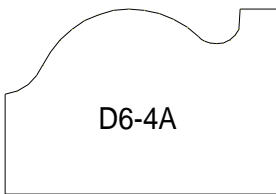
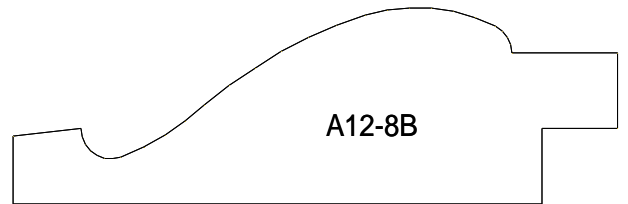
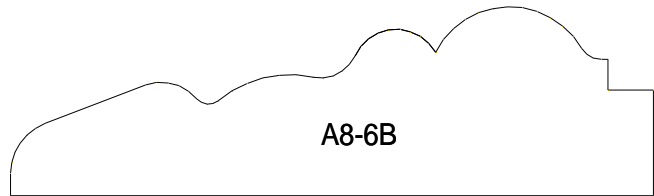
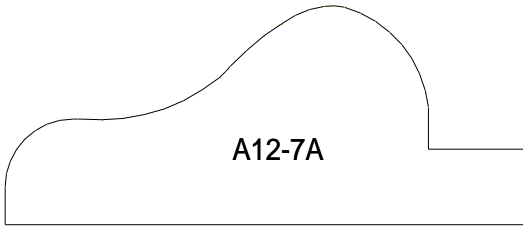
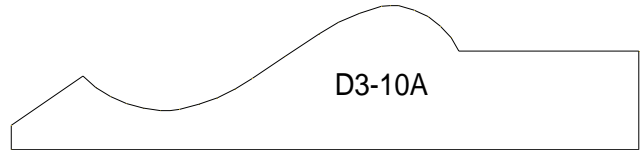
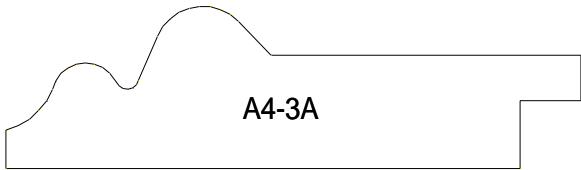
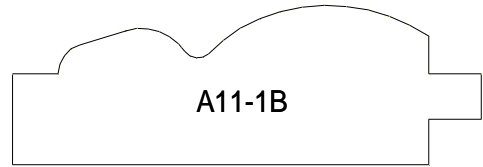
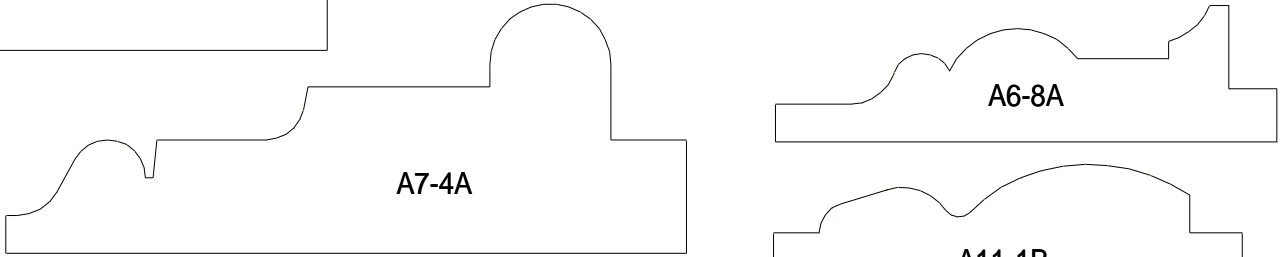
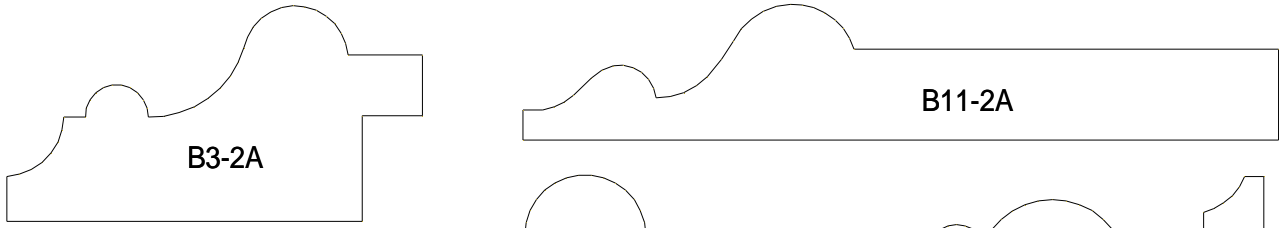
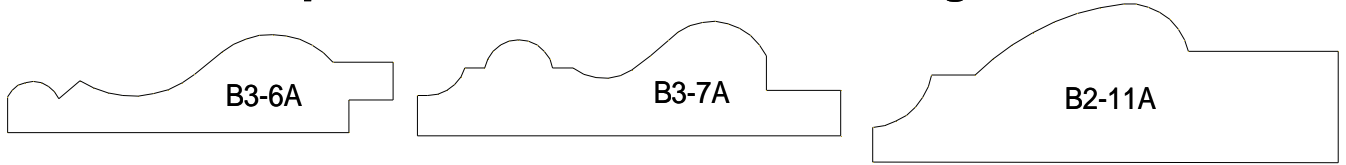

50mm



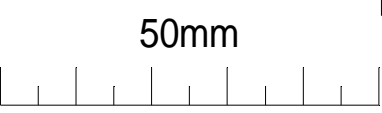
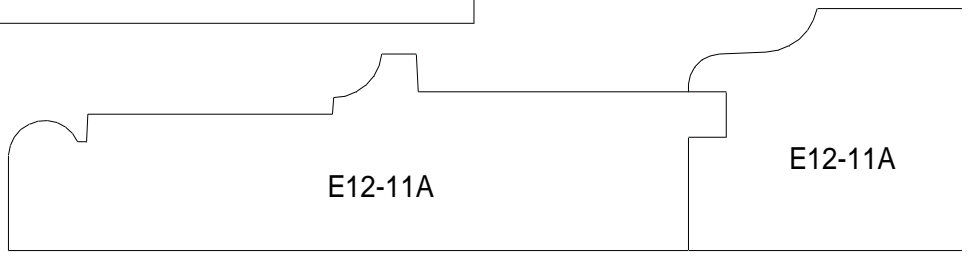
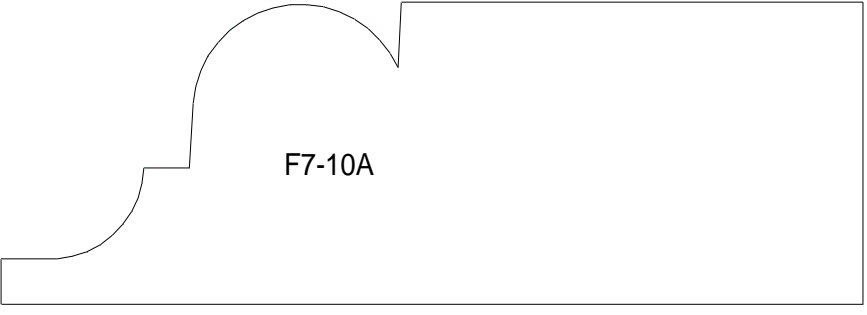
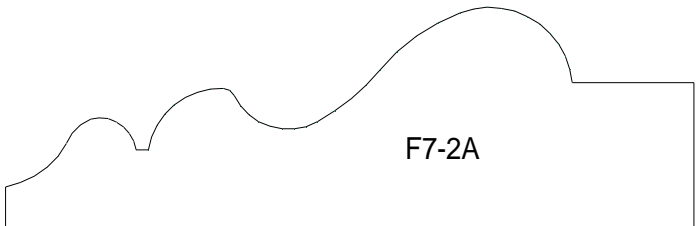
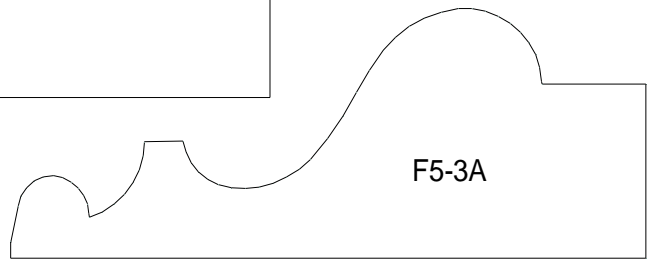
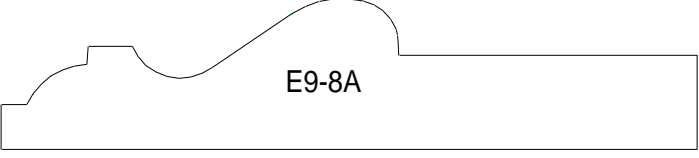
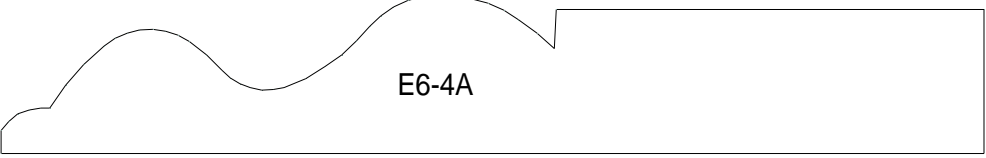
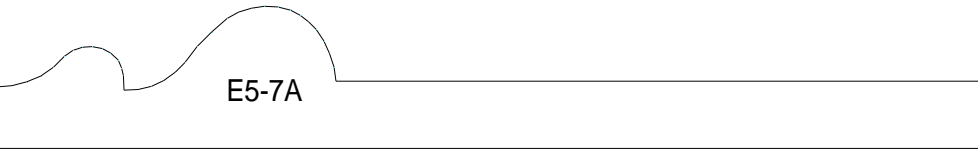
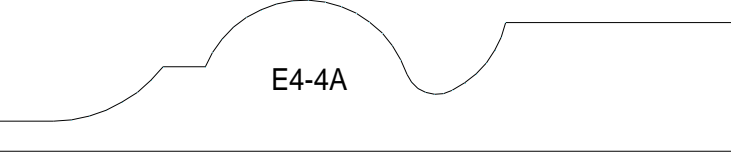
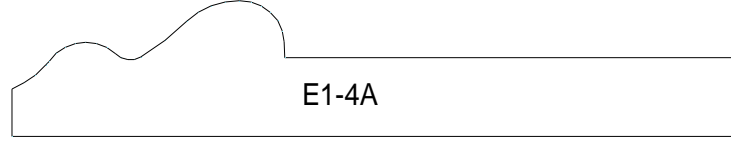
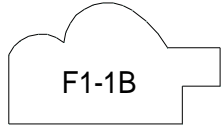
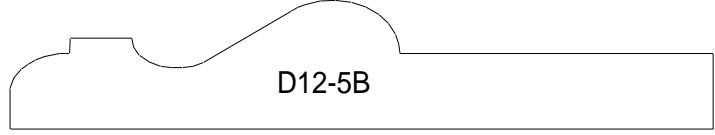
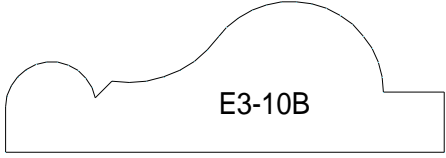
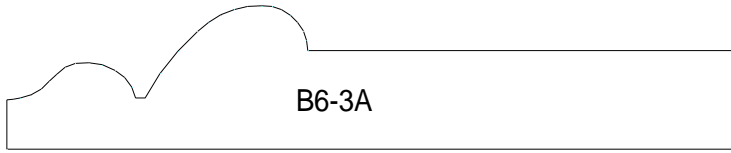

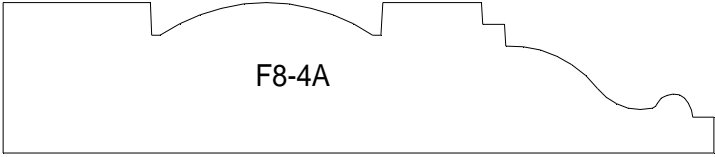

F8-4A

50mm



# Full Section Architraves

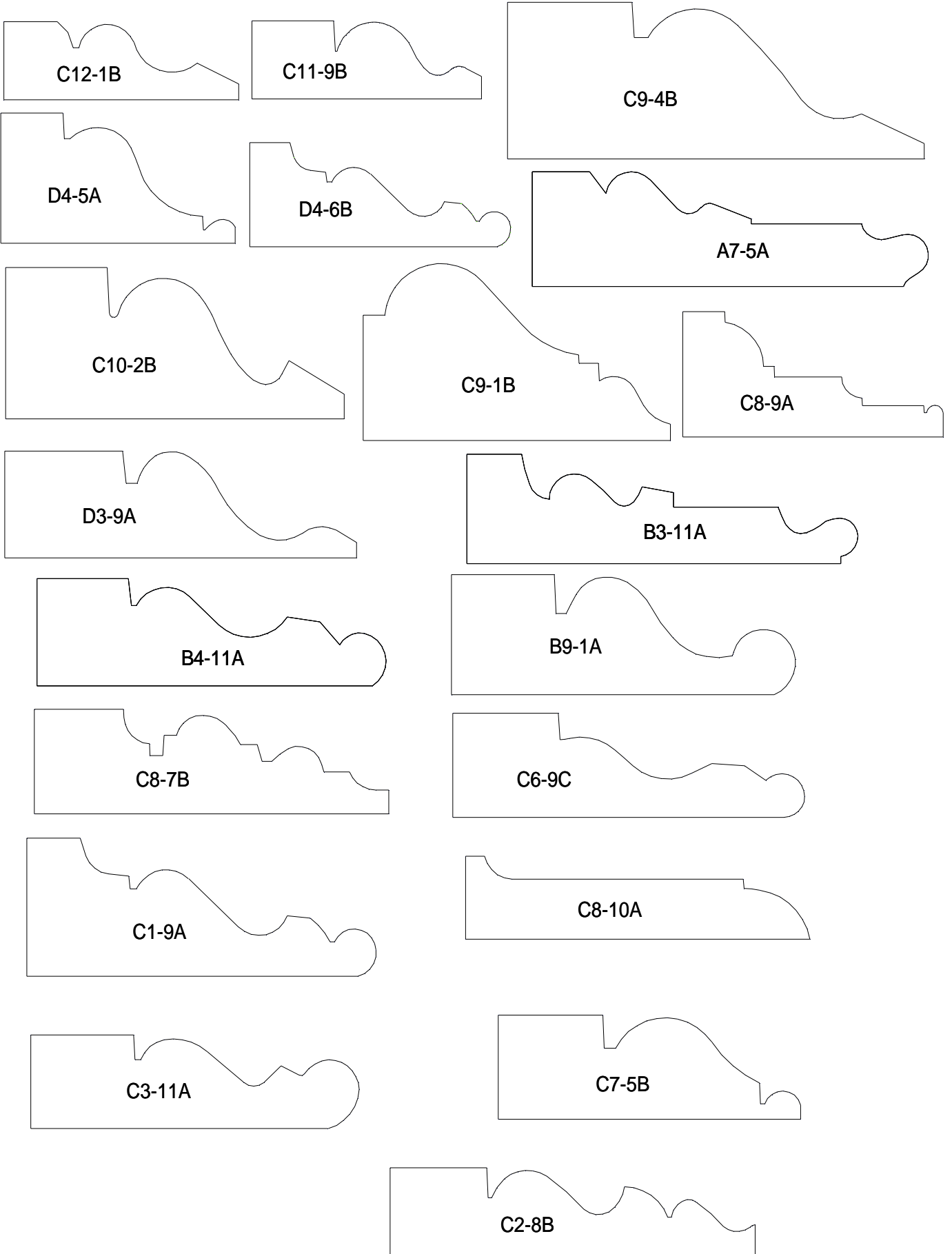

50mm



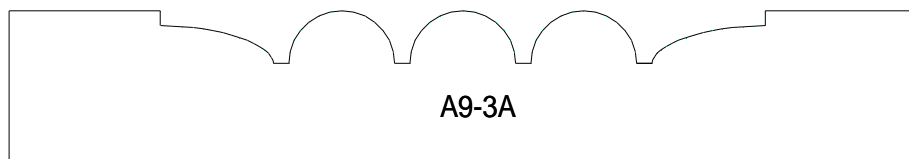
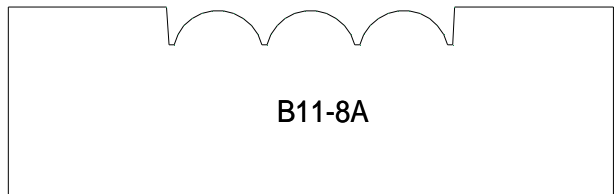
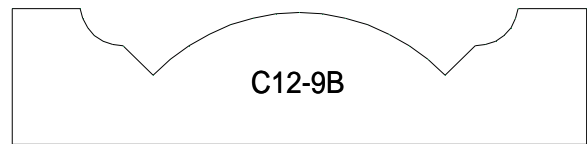
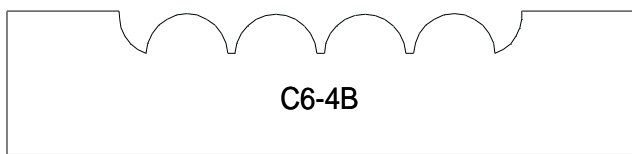
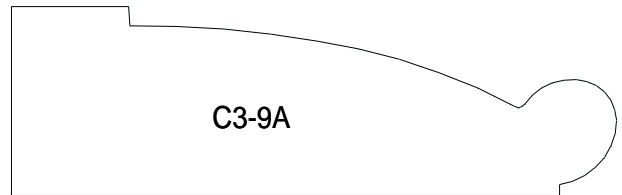
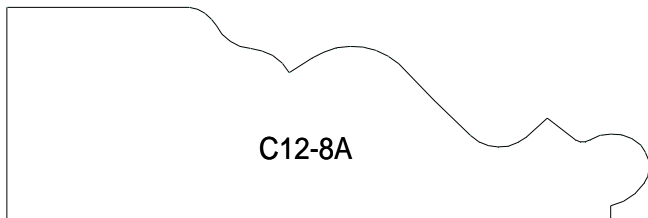
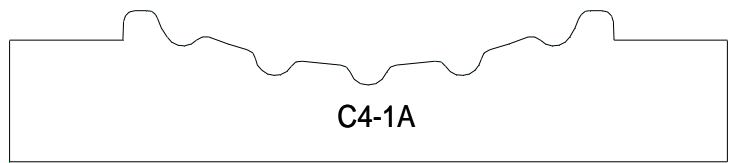
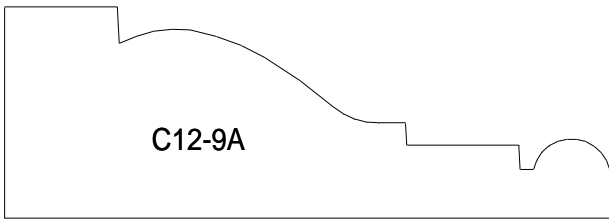
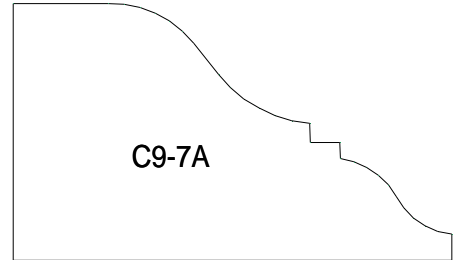
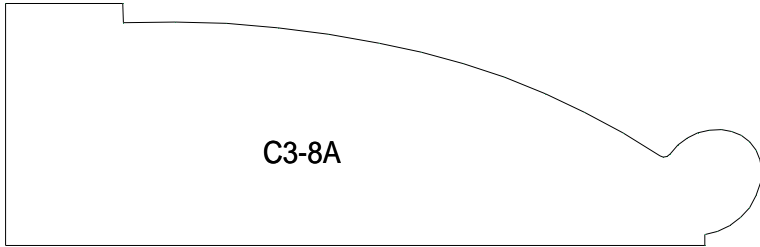
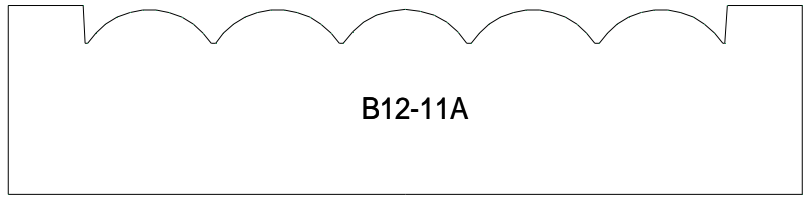
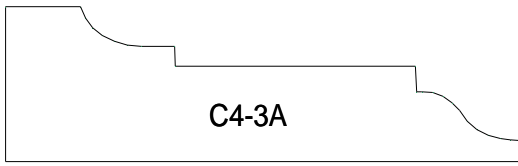
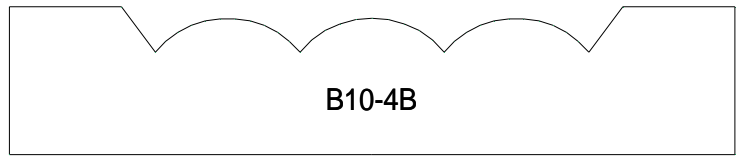
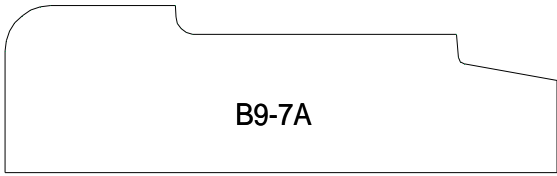

50mm





50mm



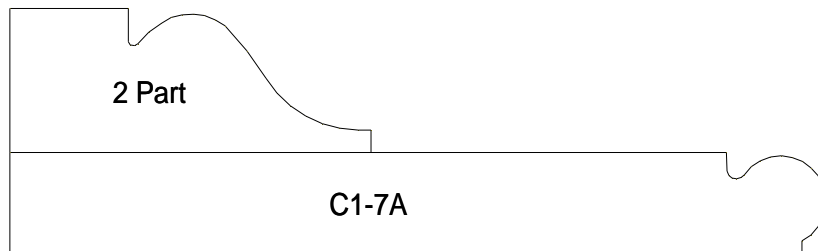
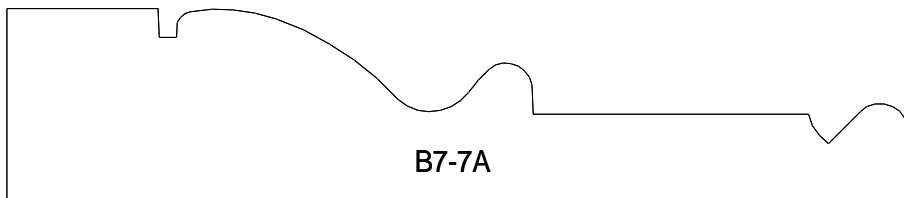
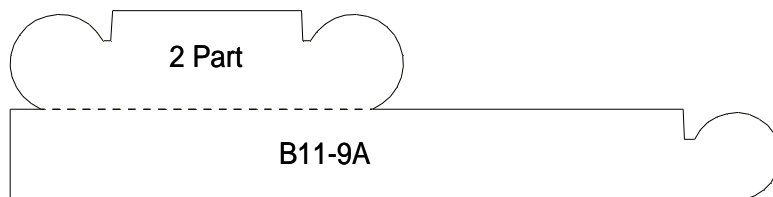
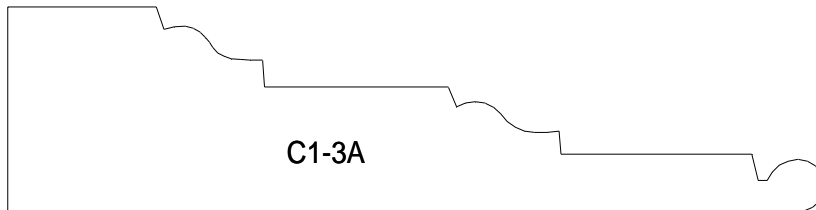
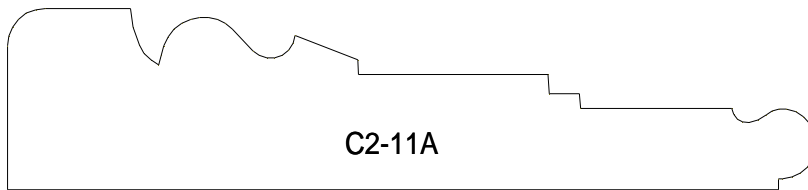
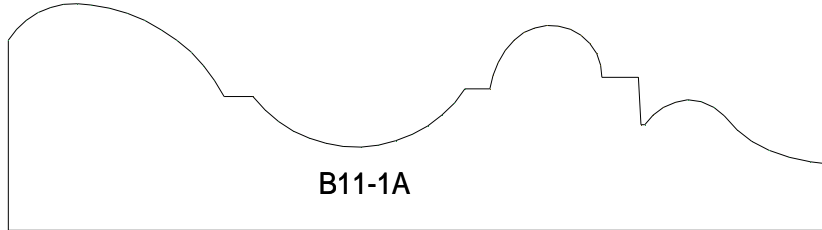
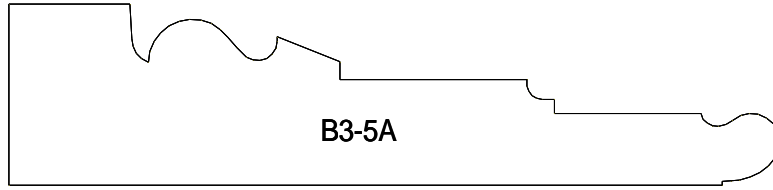
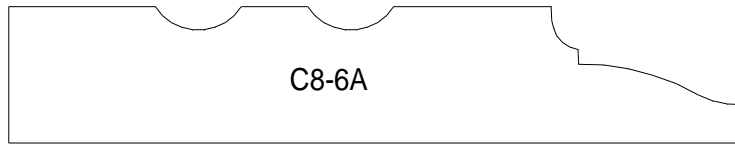

50mm



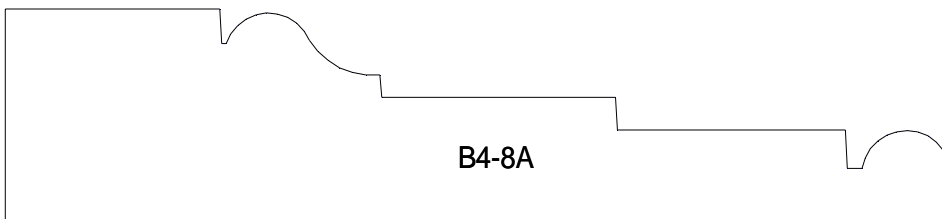
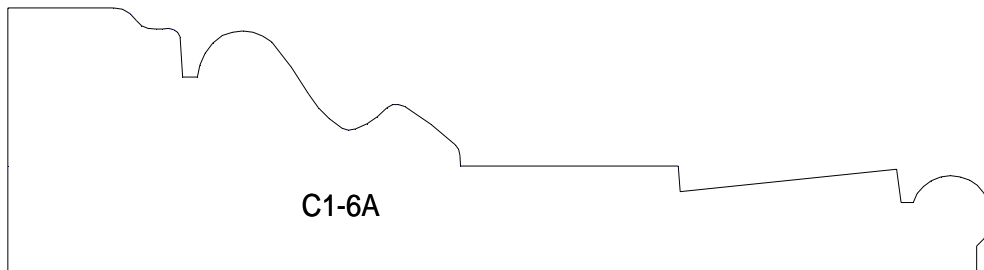
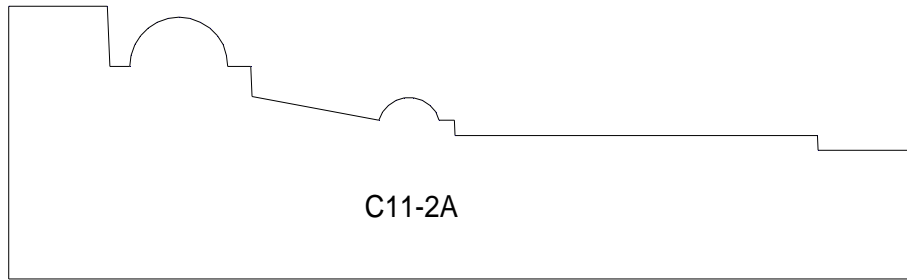
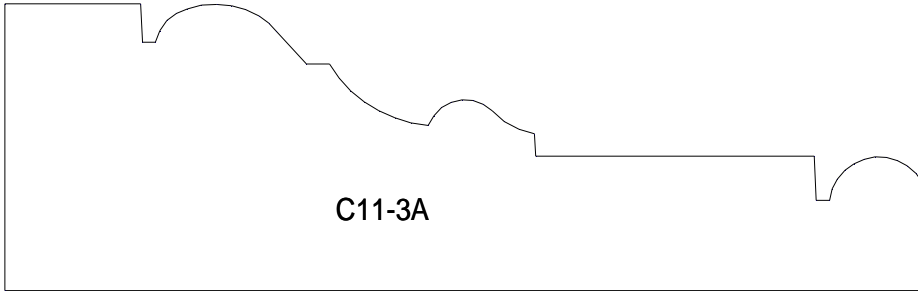
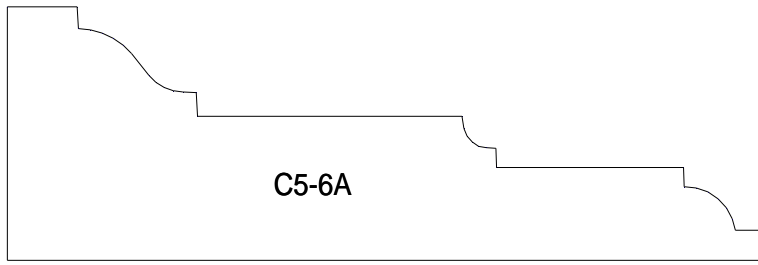

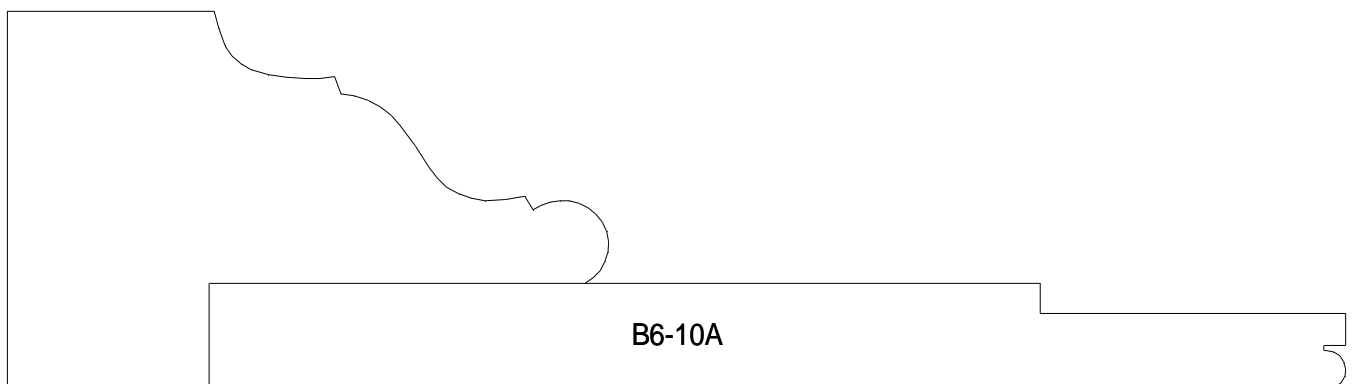
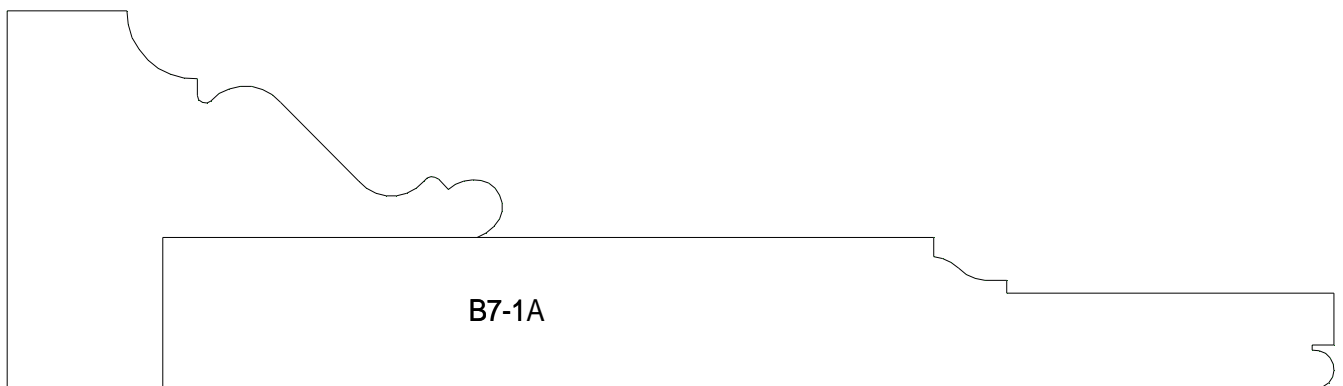
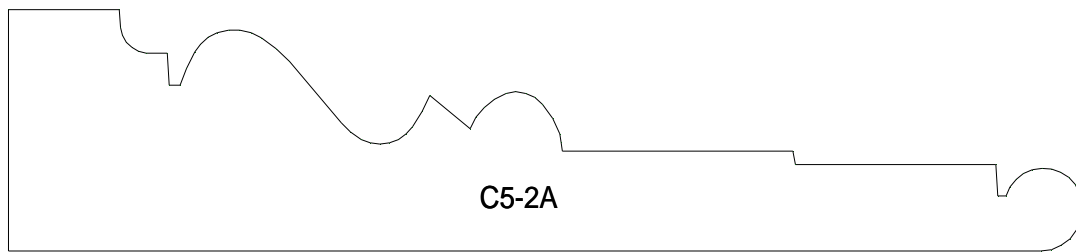
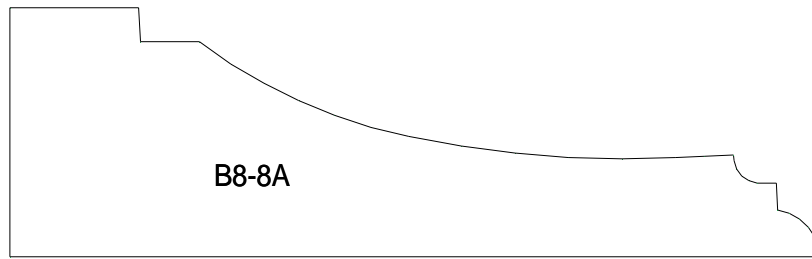
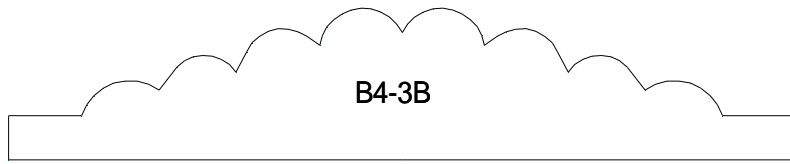

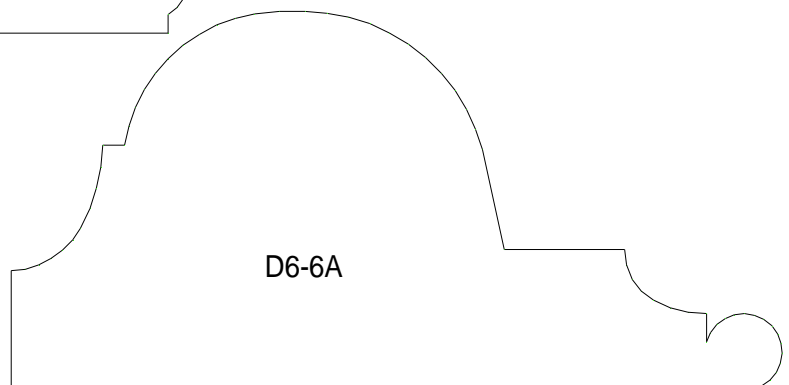
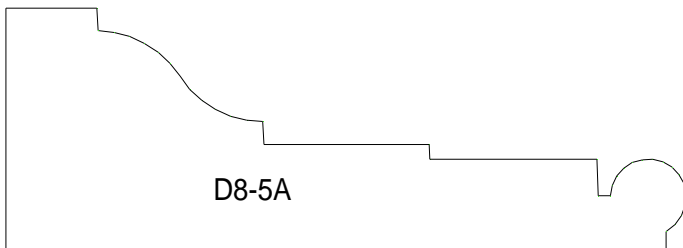
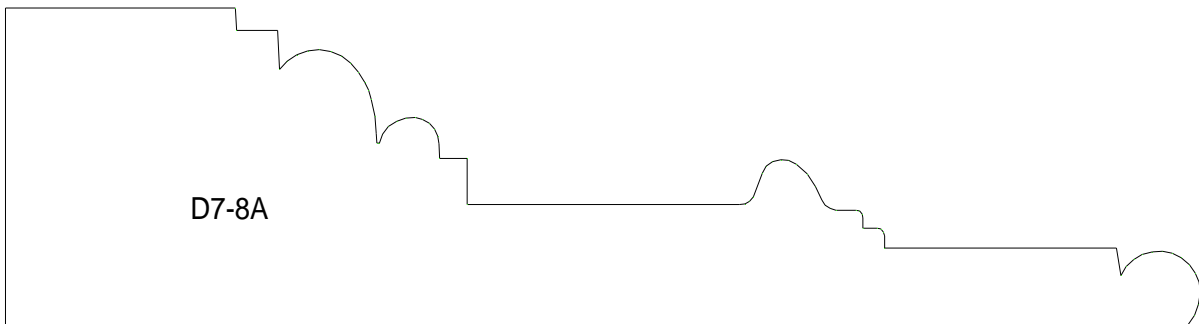
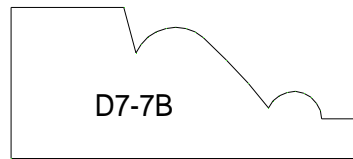
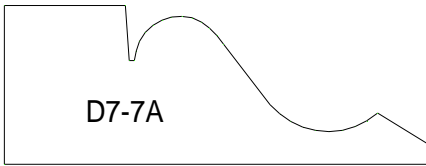
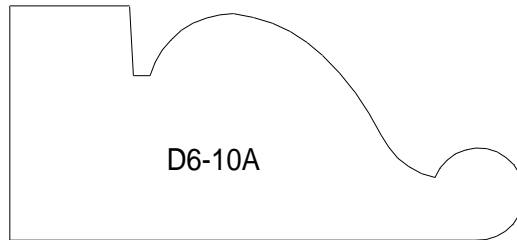
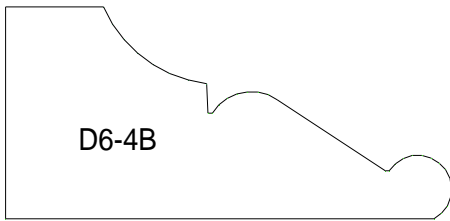
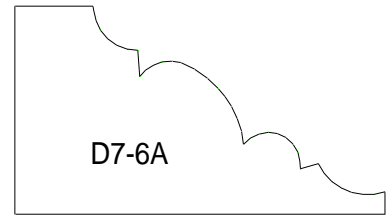
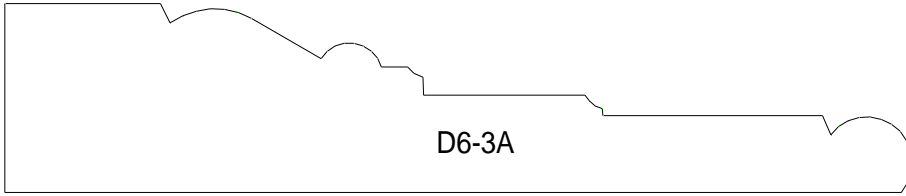
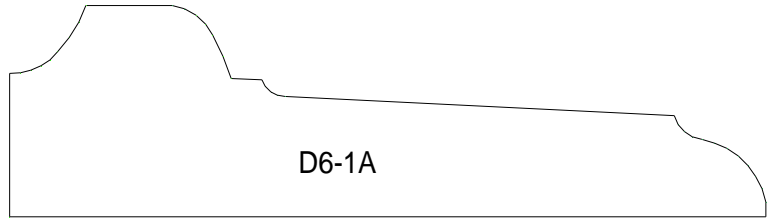

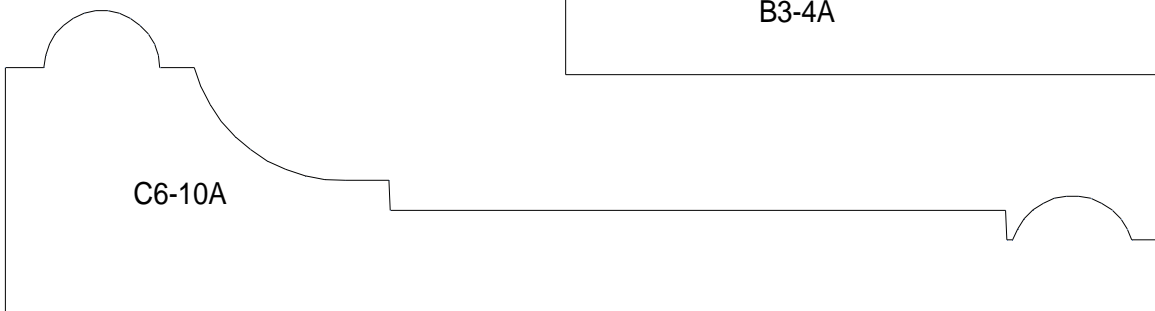
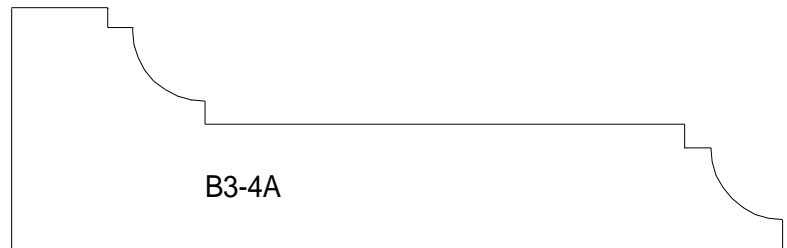
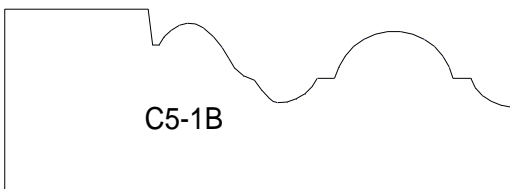
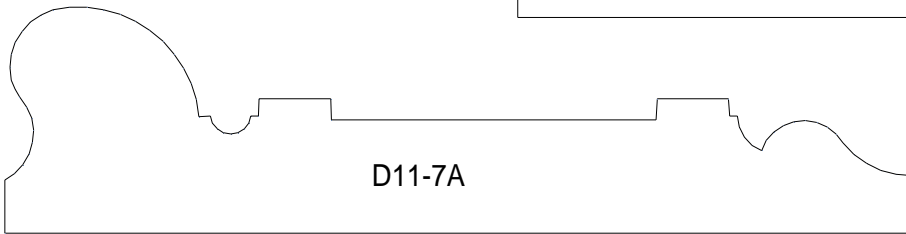
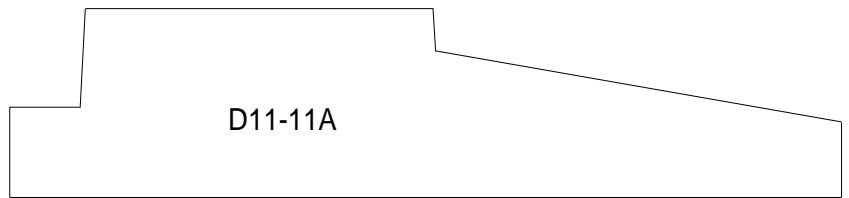
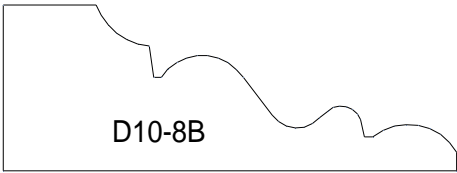
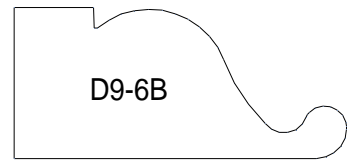
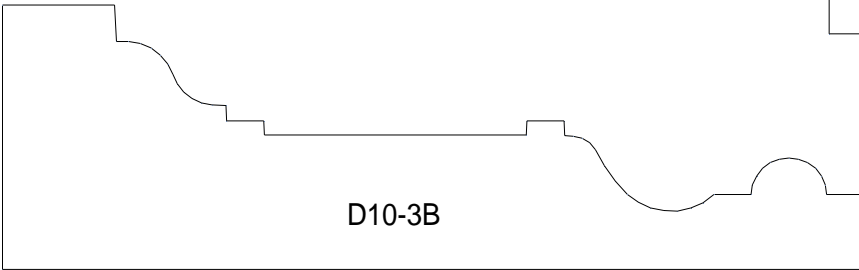
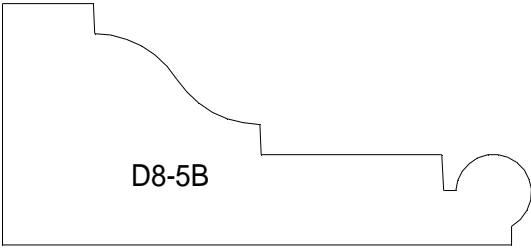
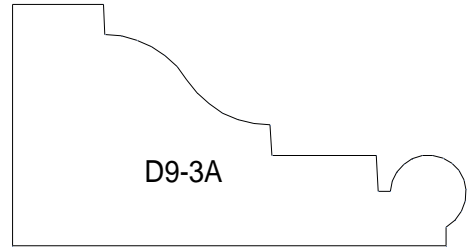
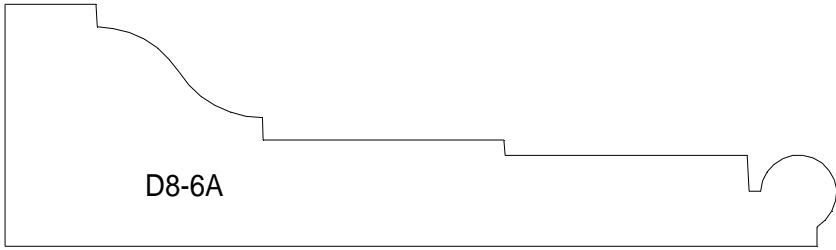

50mm



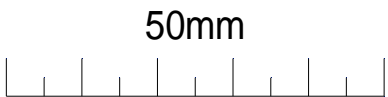
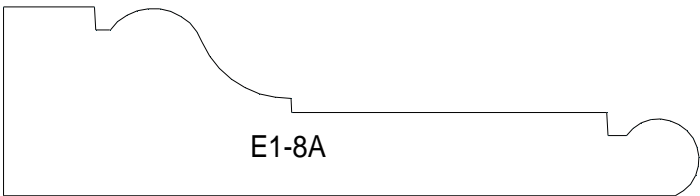
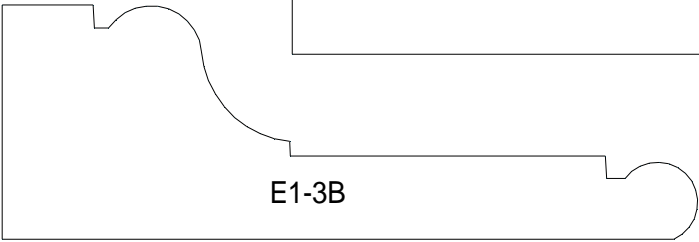
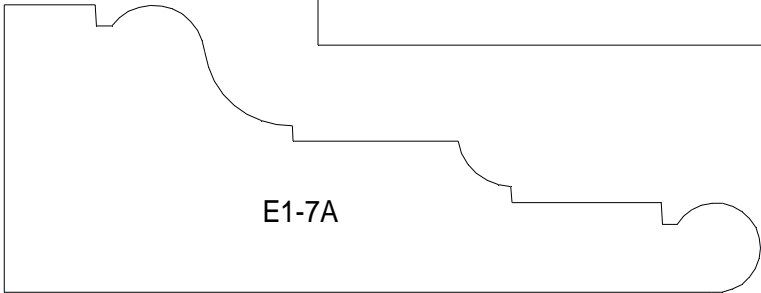
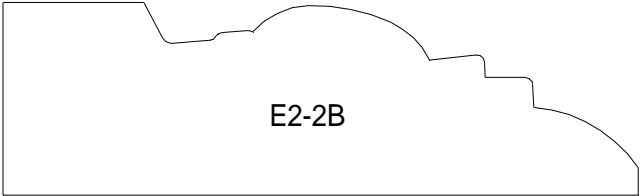
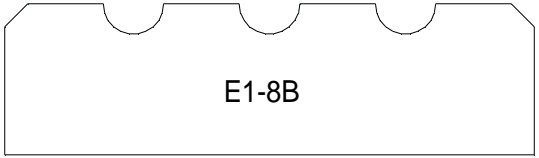
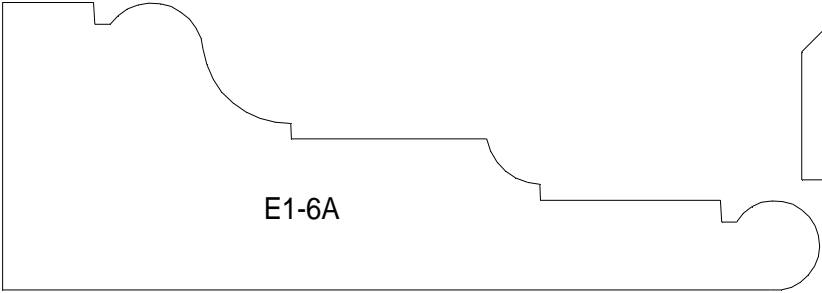
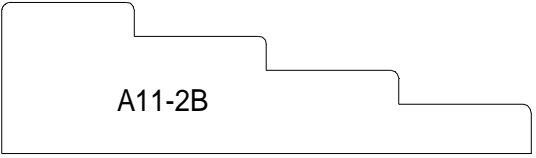
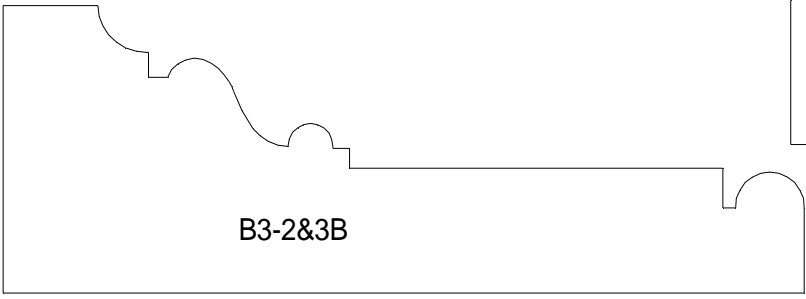

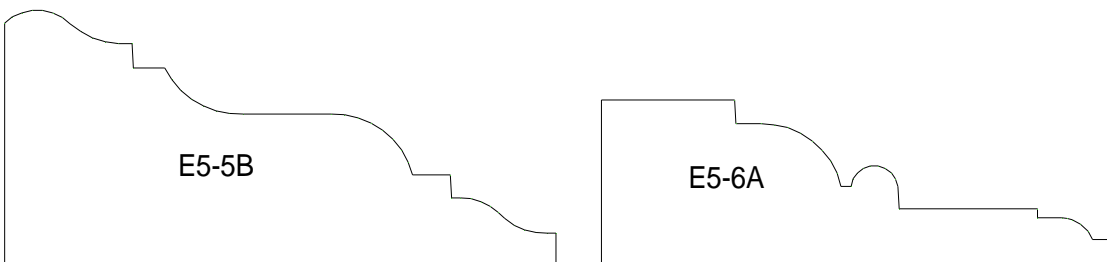
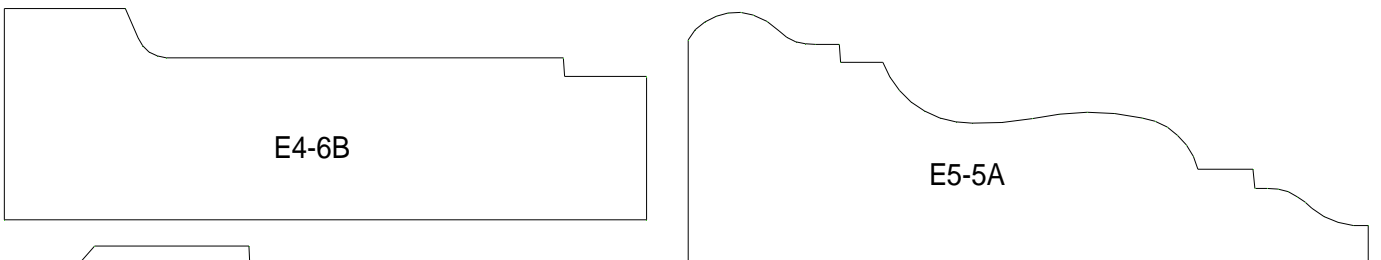
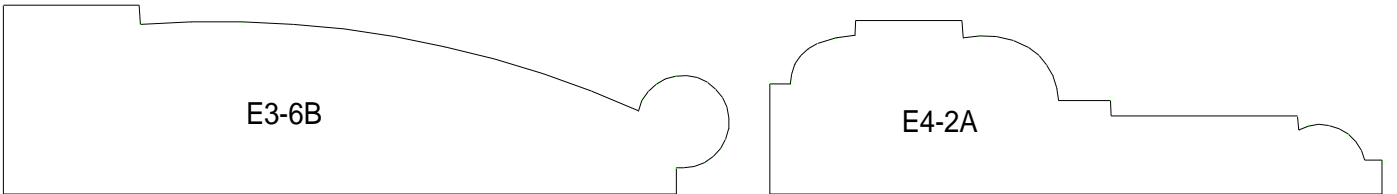
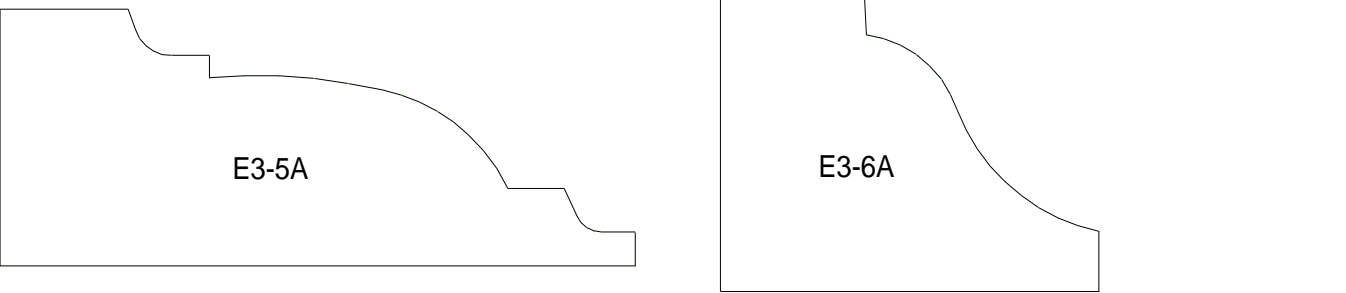
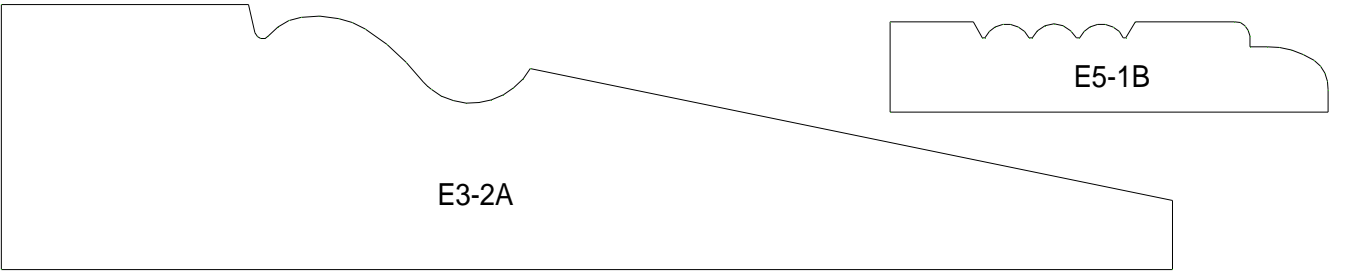
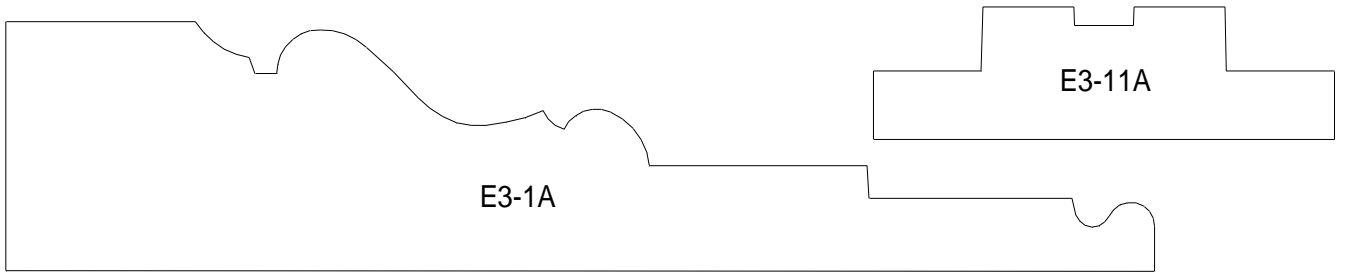

50mm



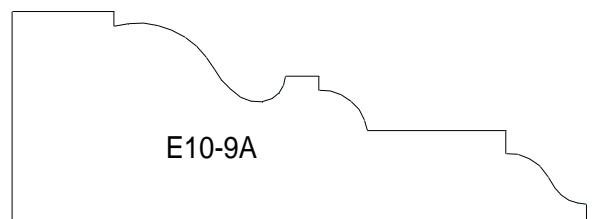
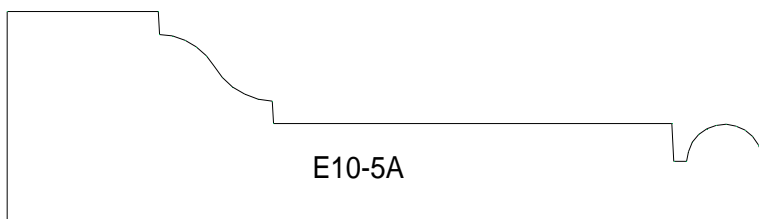
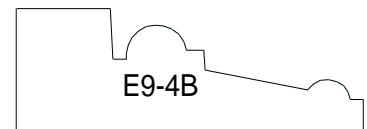
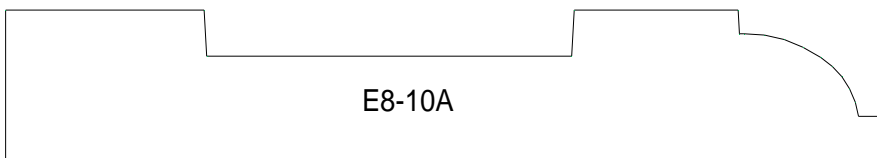
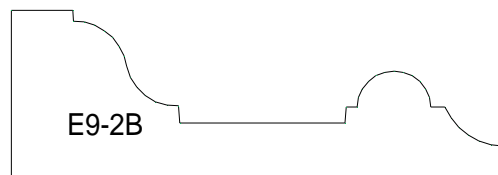
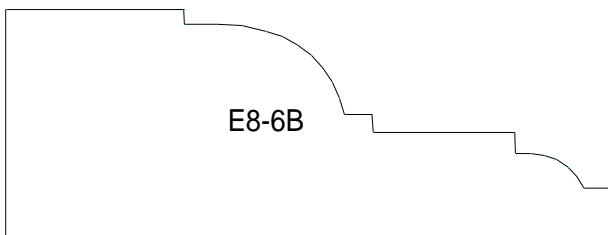
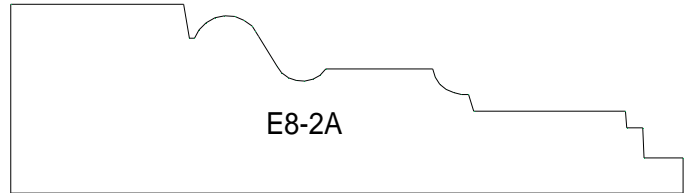
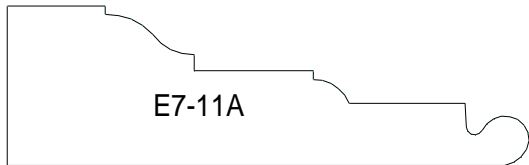
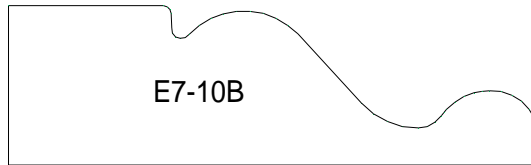
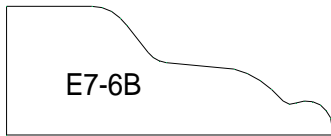
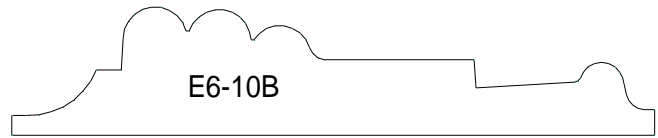
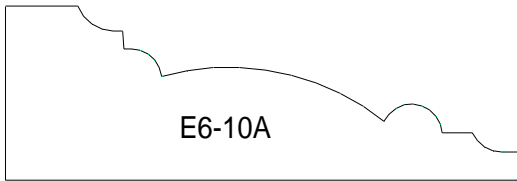
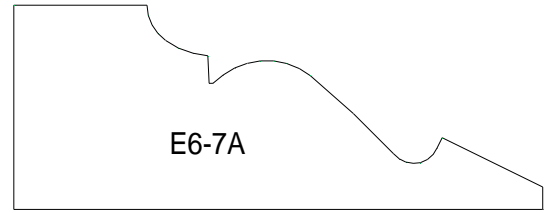
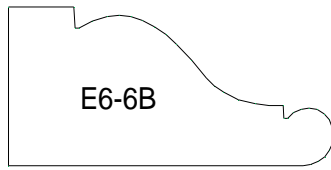
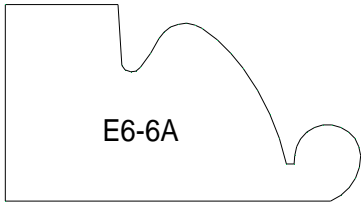
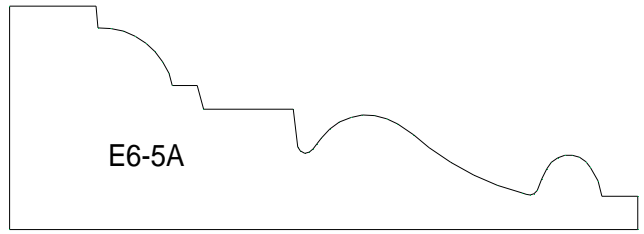
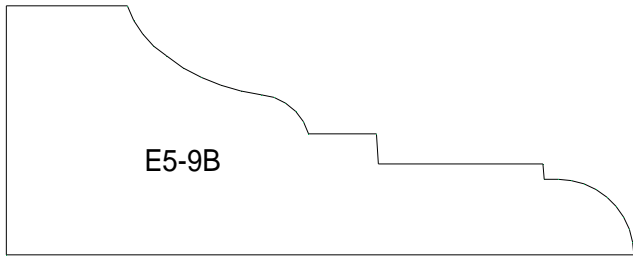

50mm



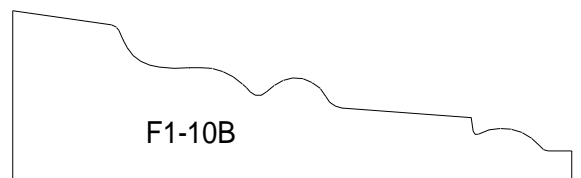
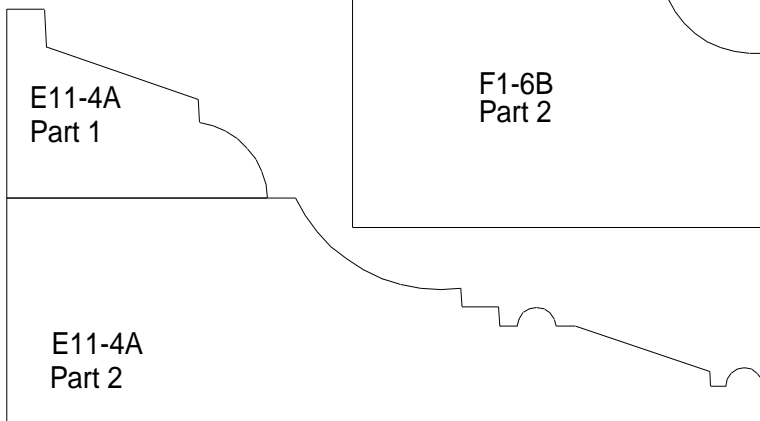
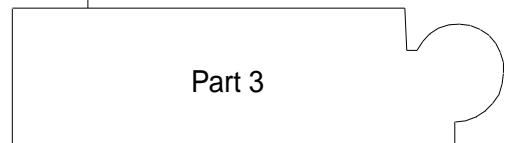
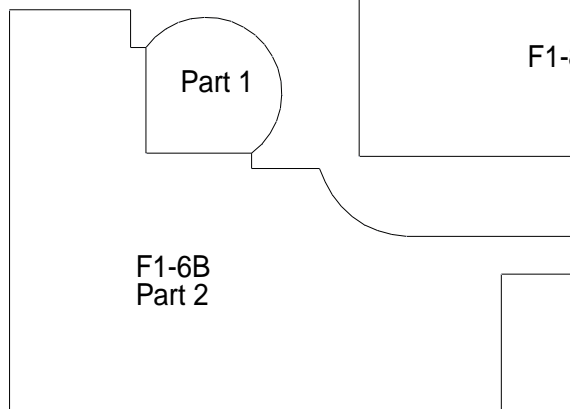
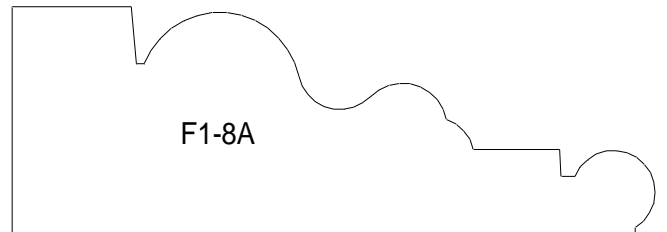
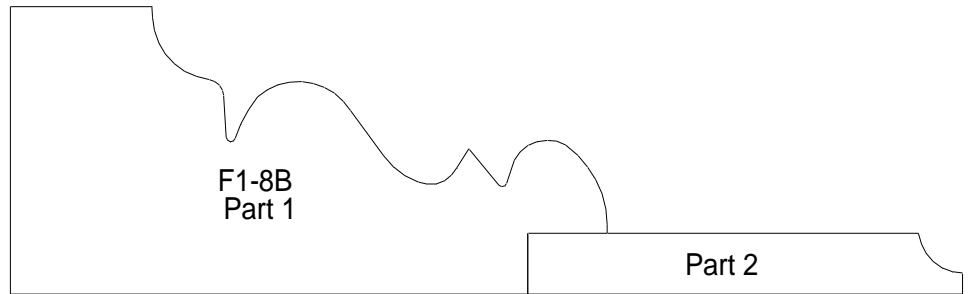
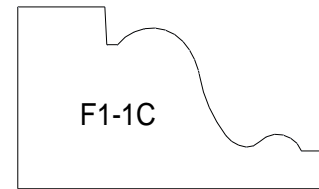
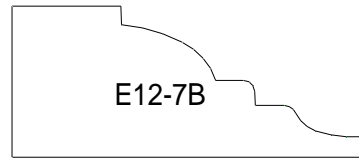
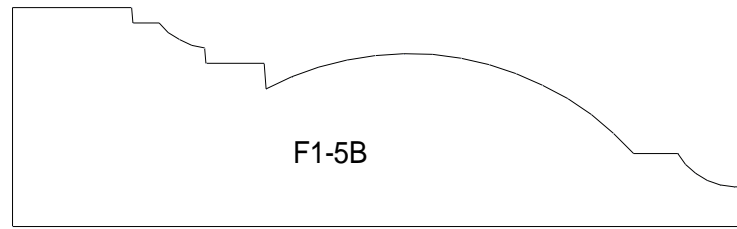
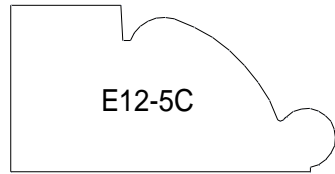
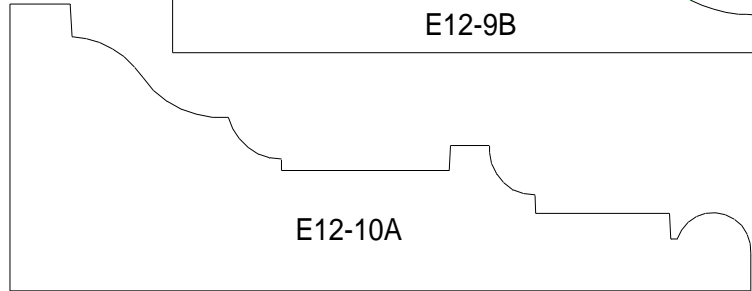
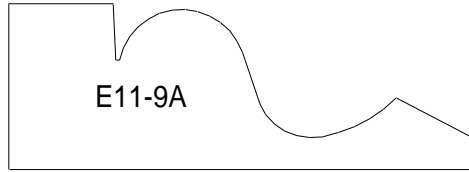
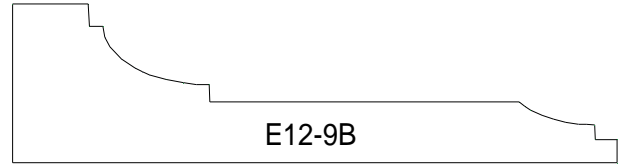
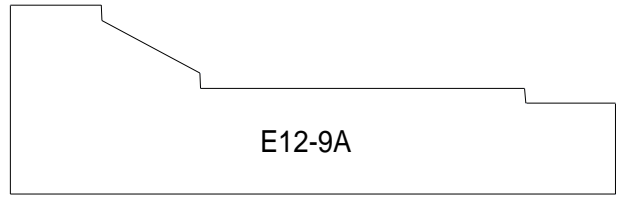
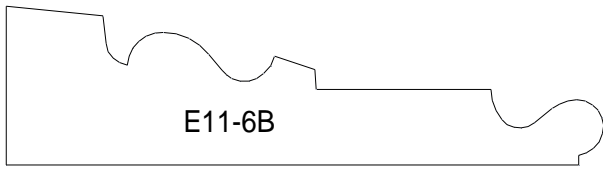

50mm

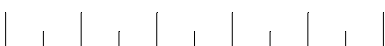

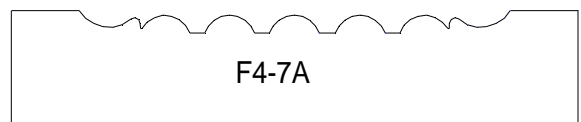
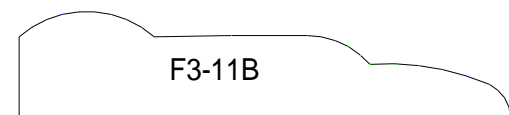
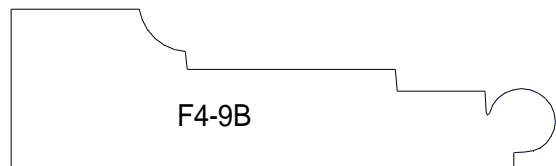
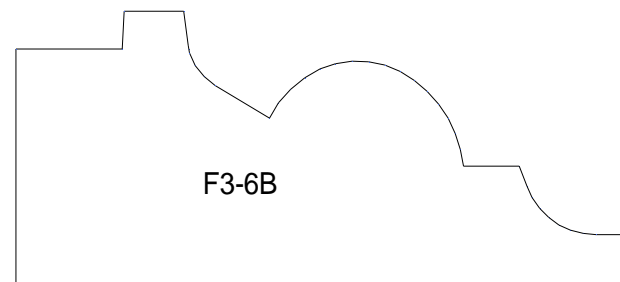
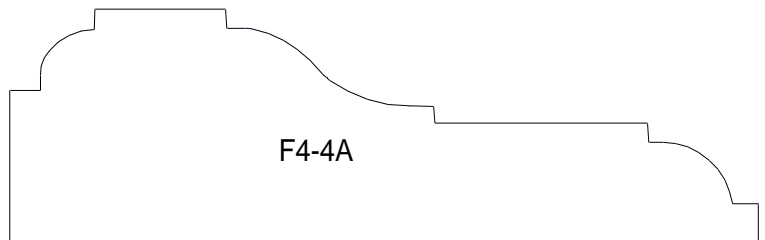
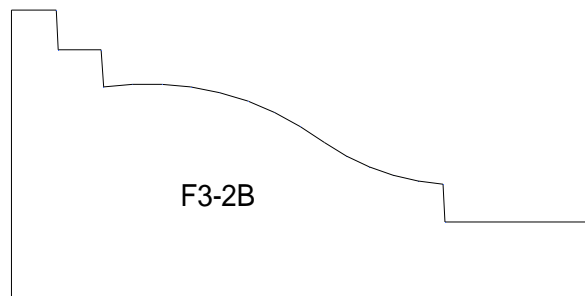
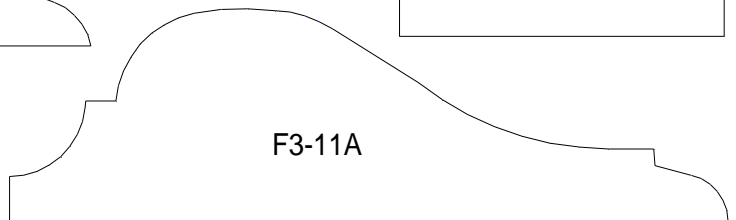
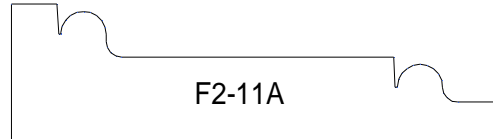
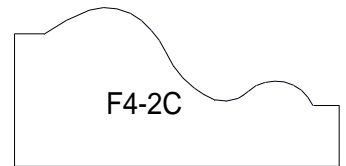
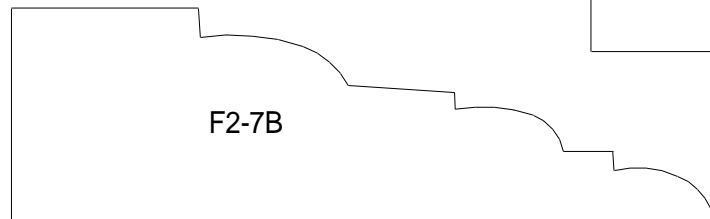
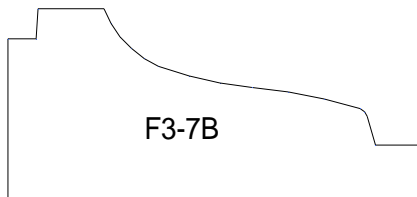
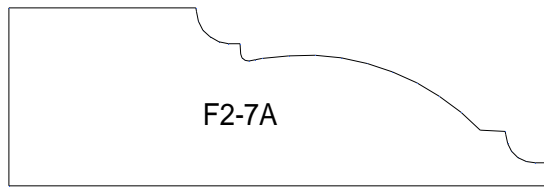
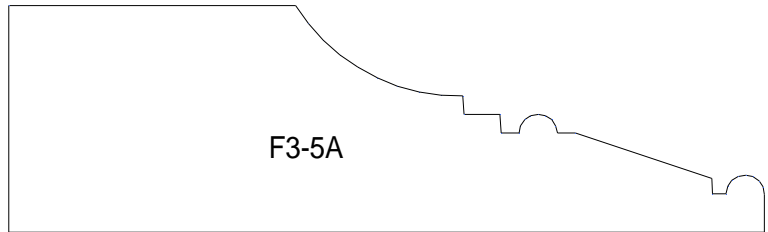
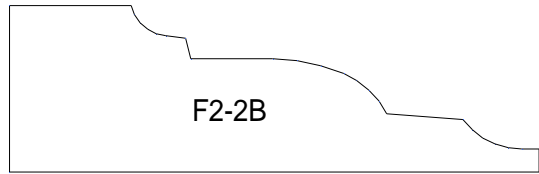
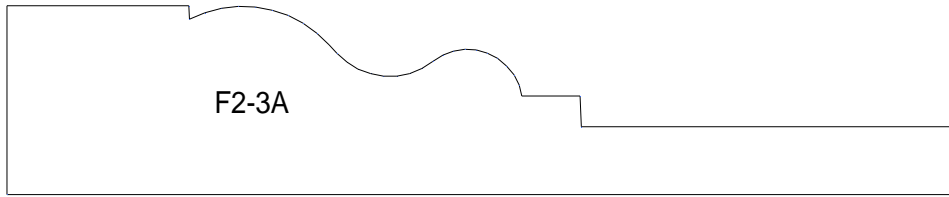
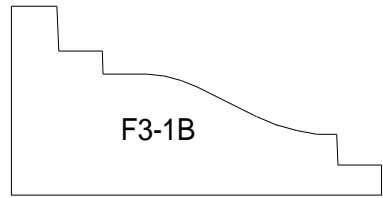
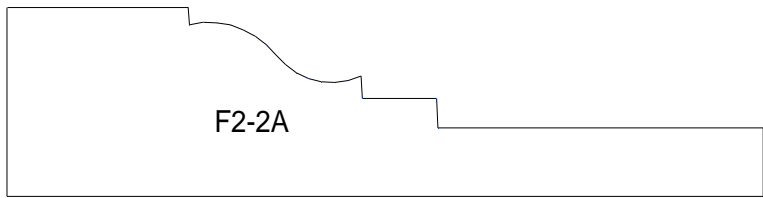

50mm



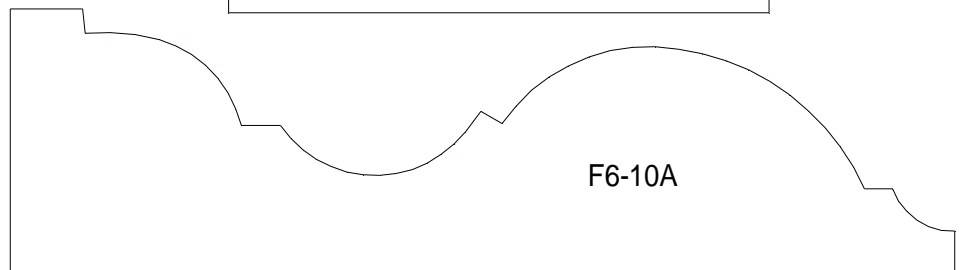
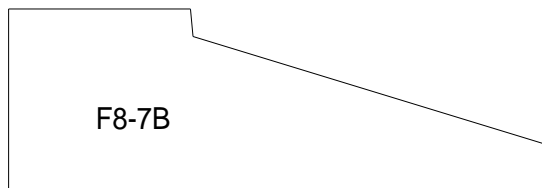
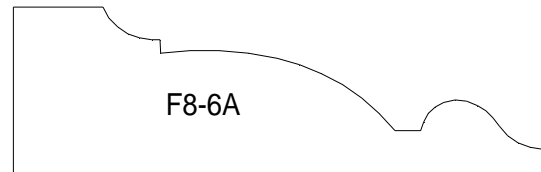
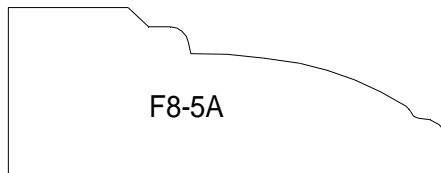
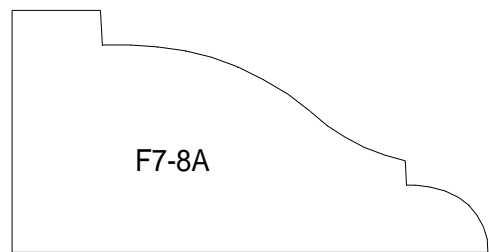
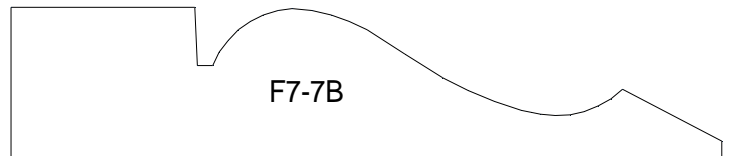
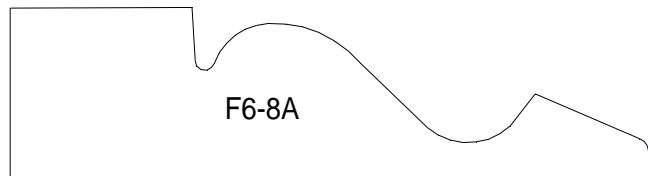
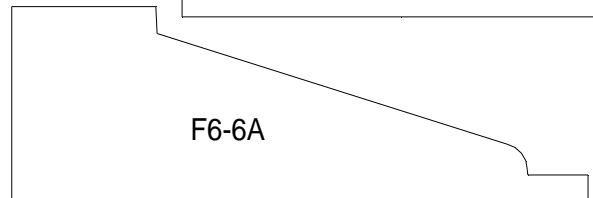
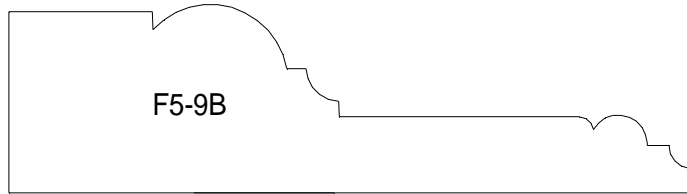
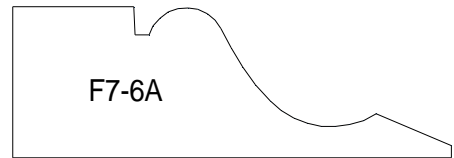
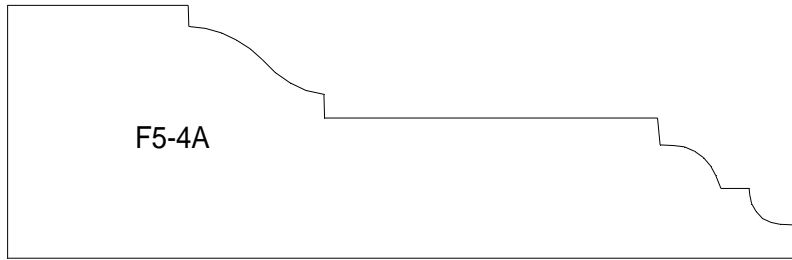
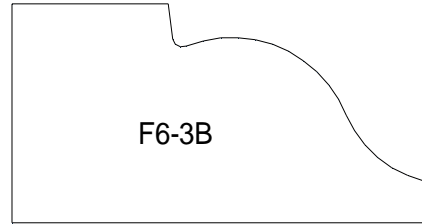
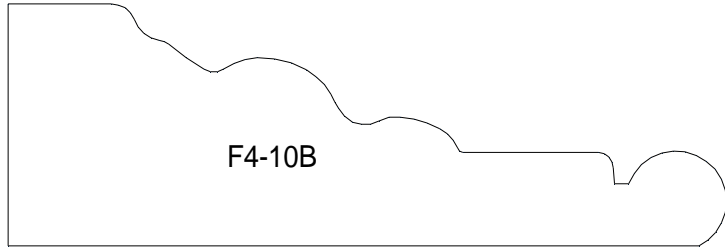
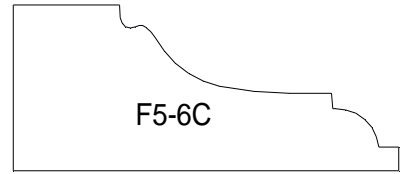
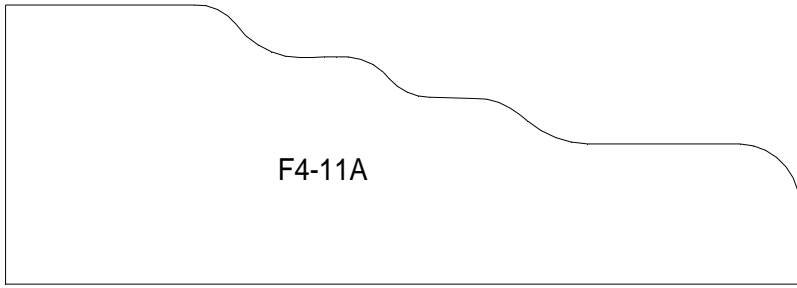

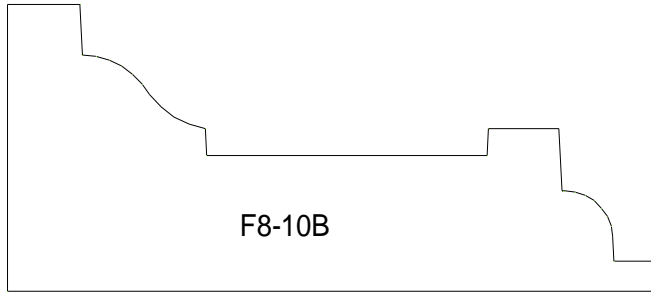
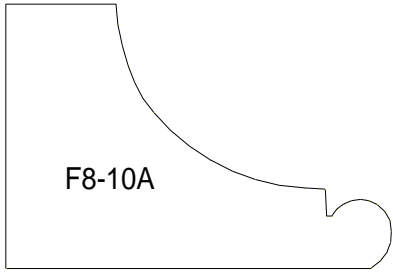

50mm



# Dado Rails

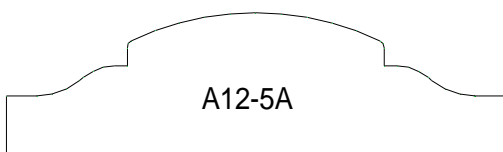
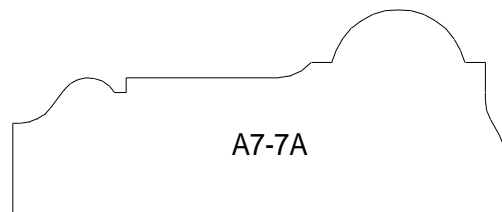
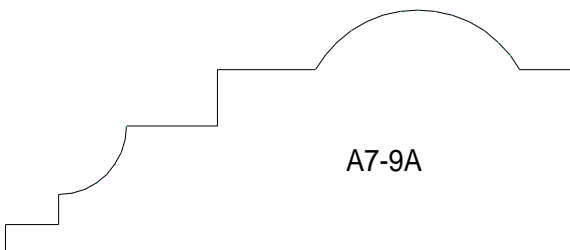
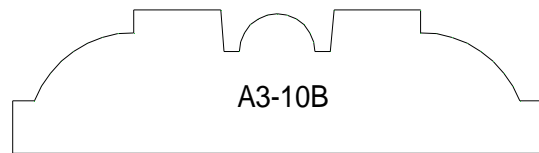
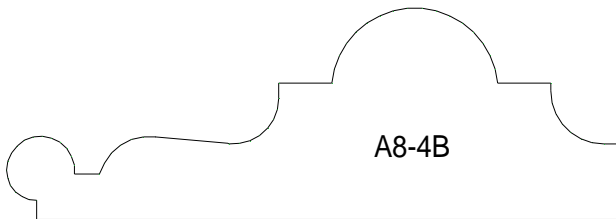
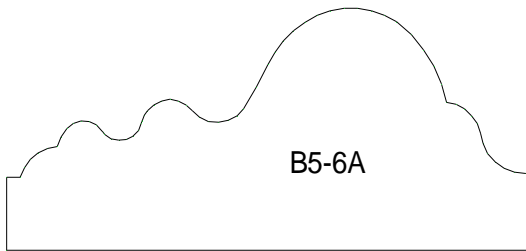
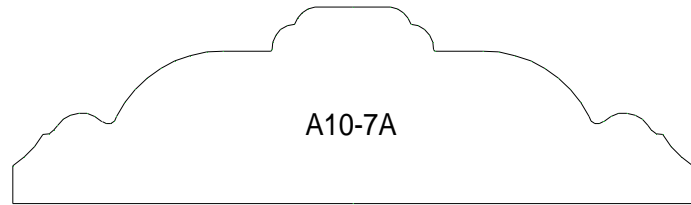
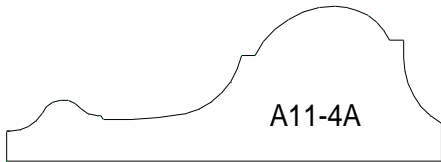
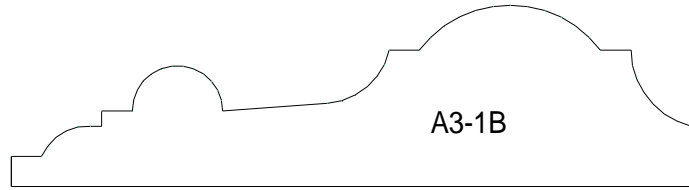
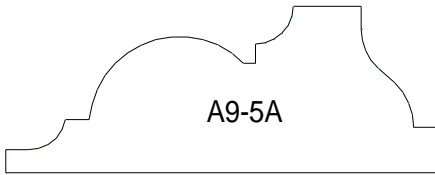
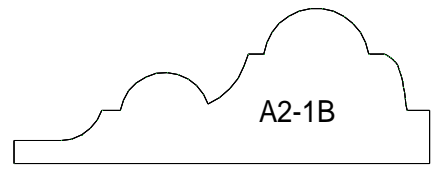
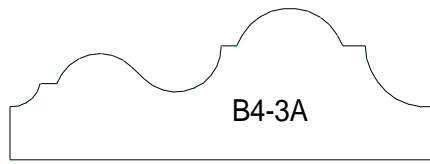
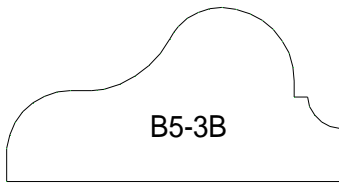

50mm



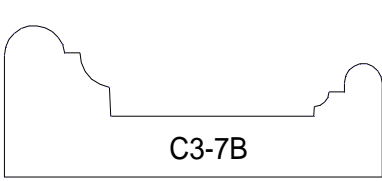

C3-7B

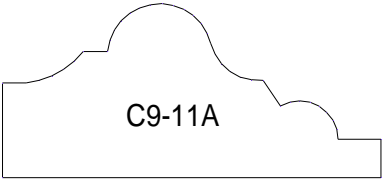

C9-11A

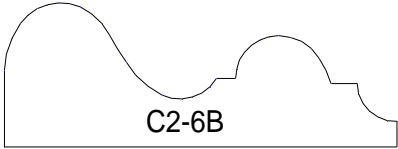

C2-6B

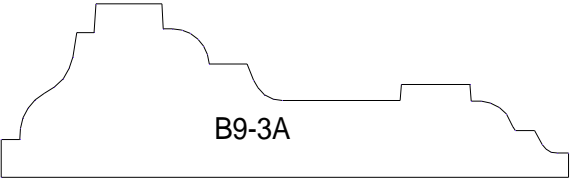

B9-3A

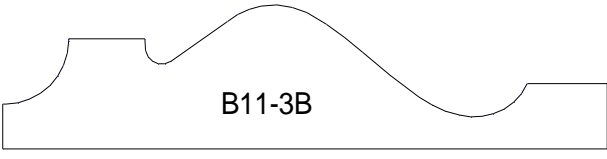

B11-3B

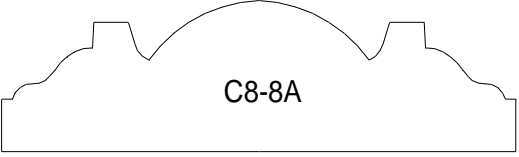

C8-8A

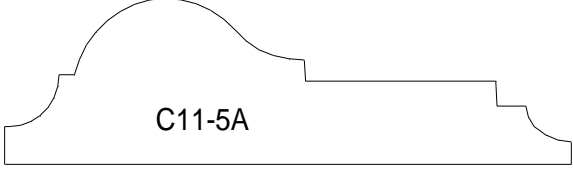

C11-5A

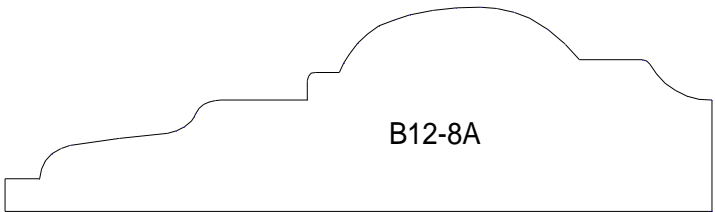

B12-8A

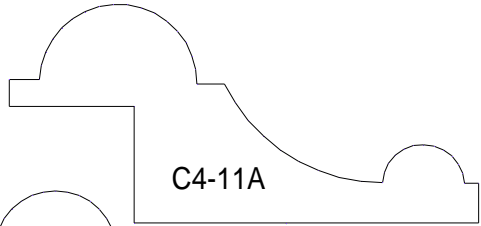

C4-11A



B9-10B



B11-7B

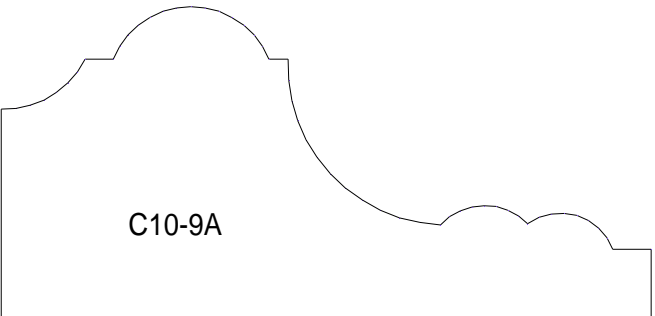

C10-9A

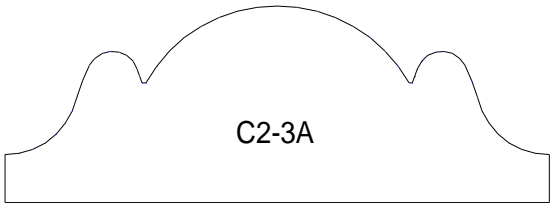

C2-3A

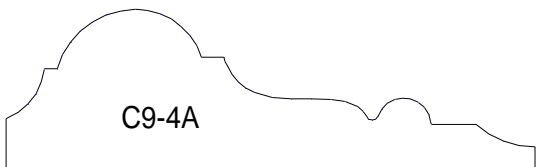

C9-4A

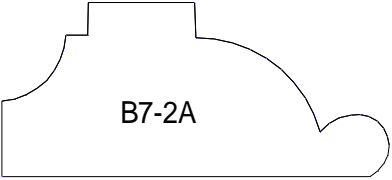

B7-2A

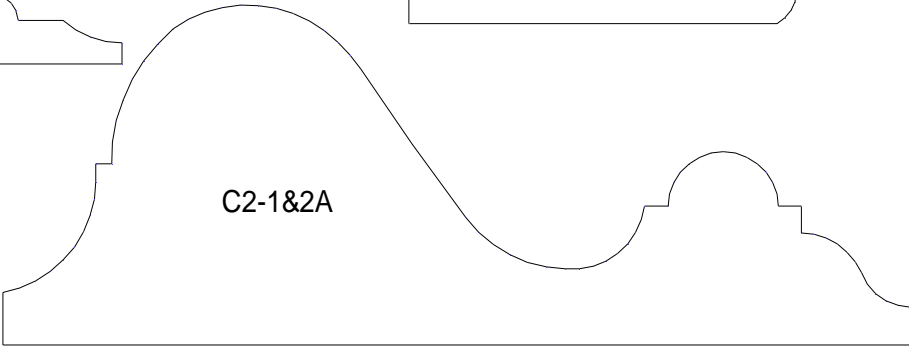

C2-1&2A

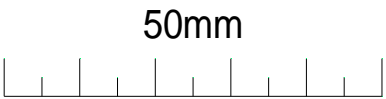

50mm

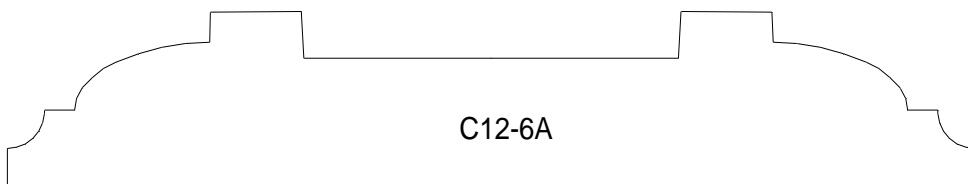
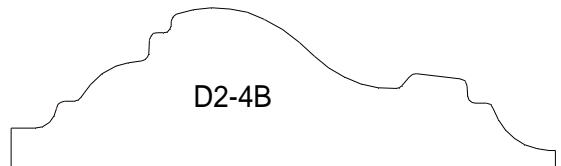
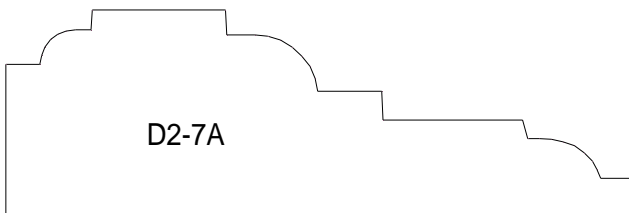
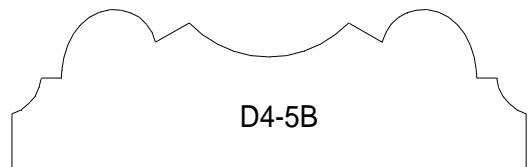
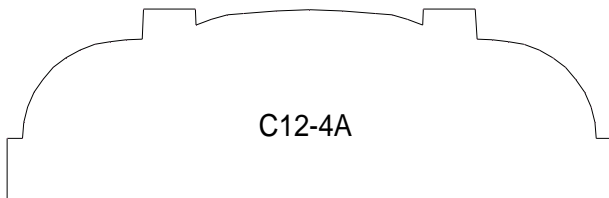
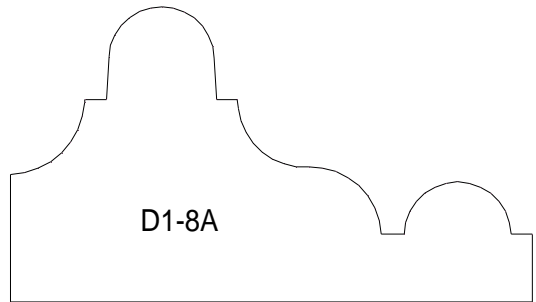
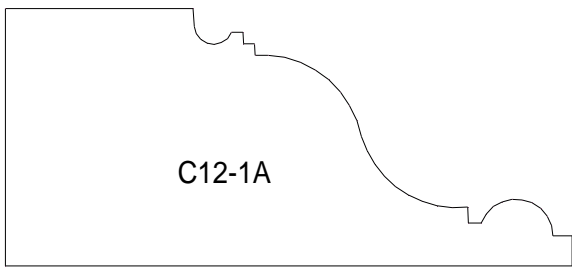
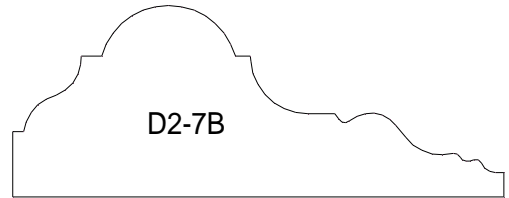
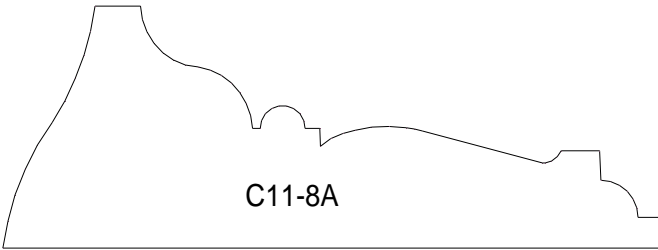
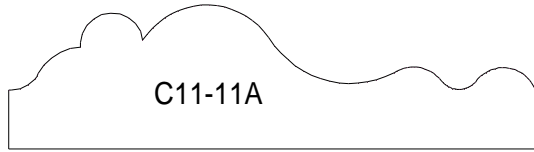
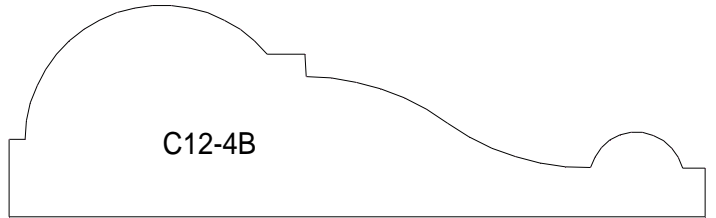
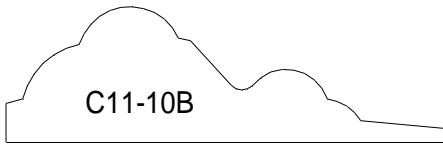

50mm



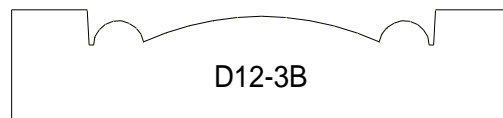
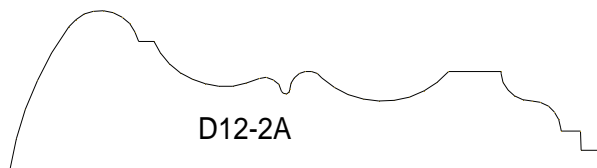
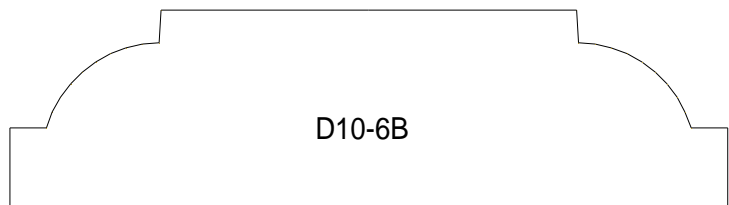
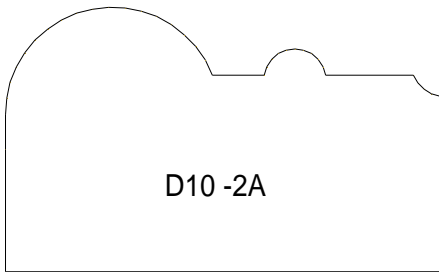
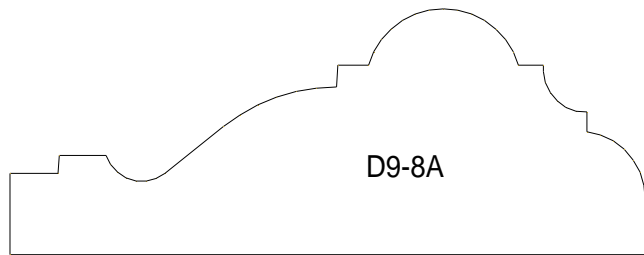
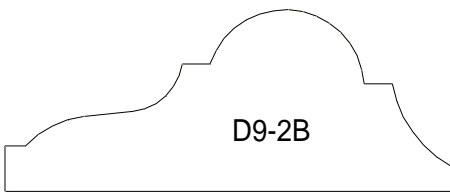
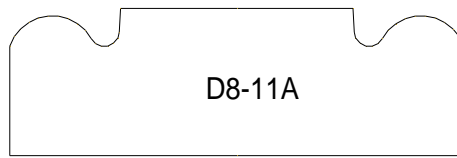
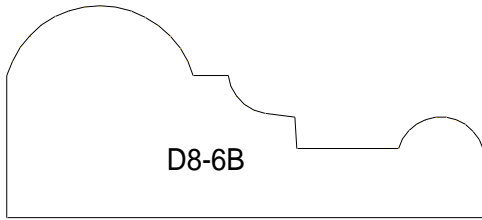
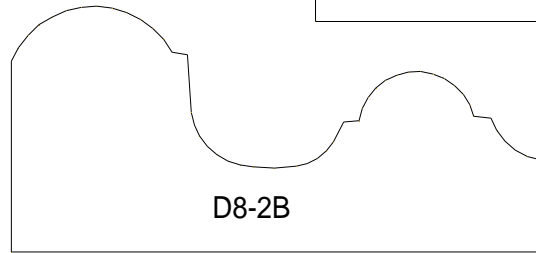
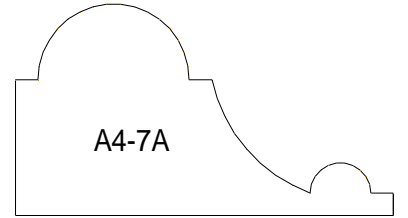
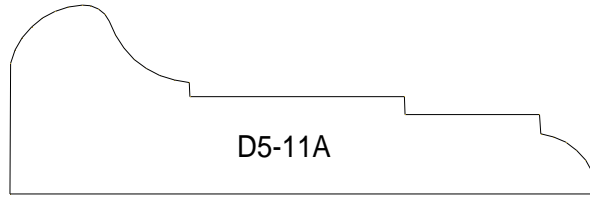
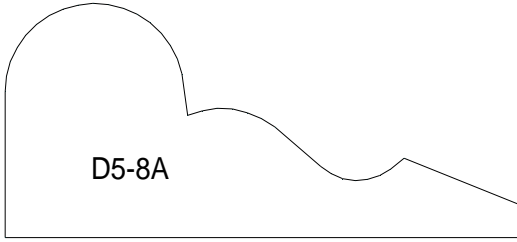
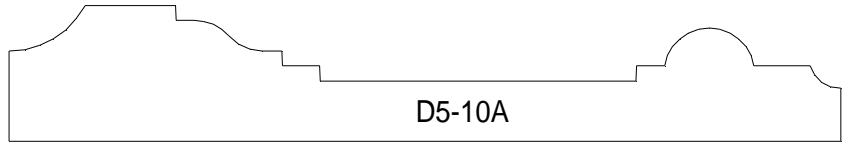

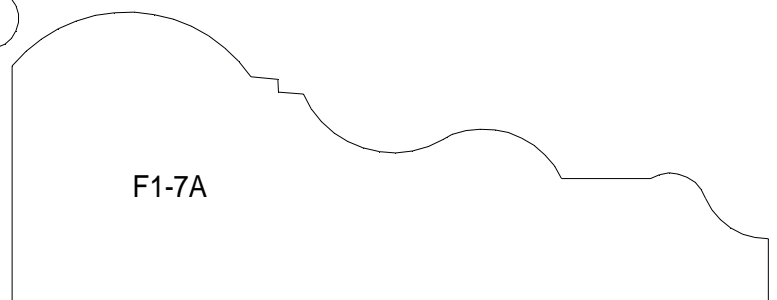
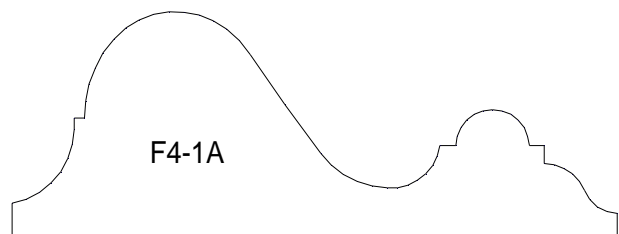
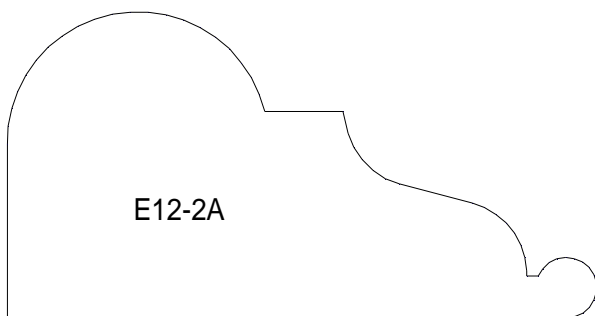
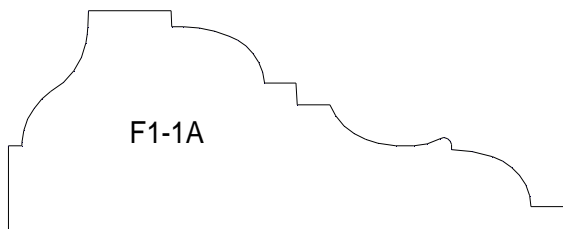
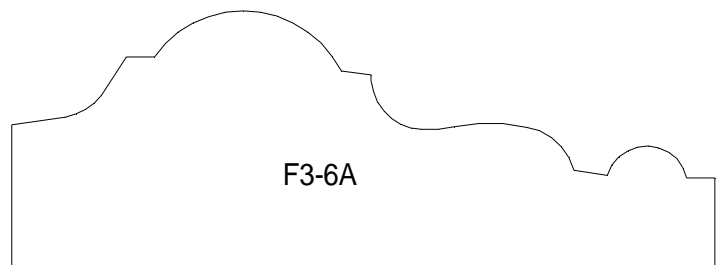
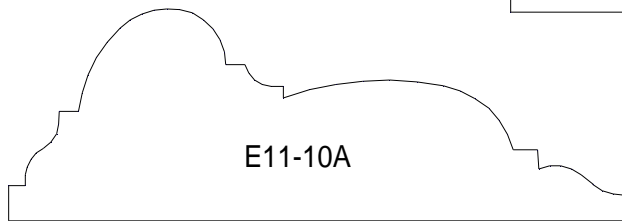
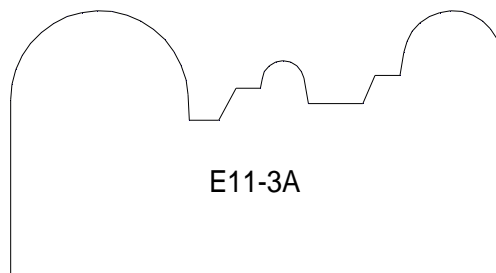
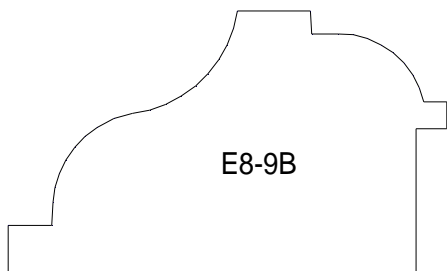
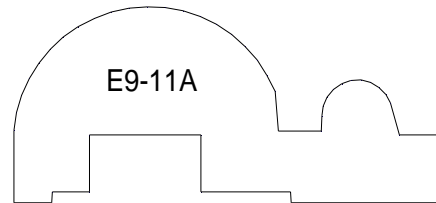
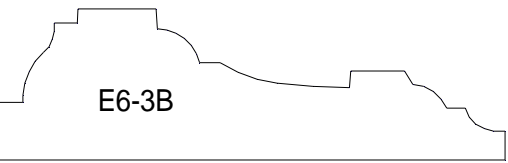
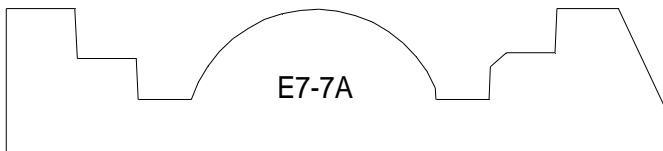
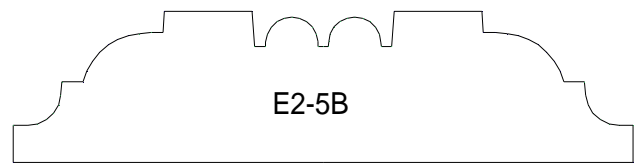
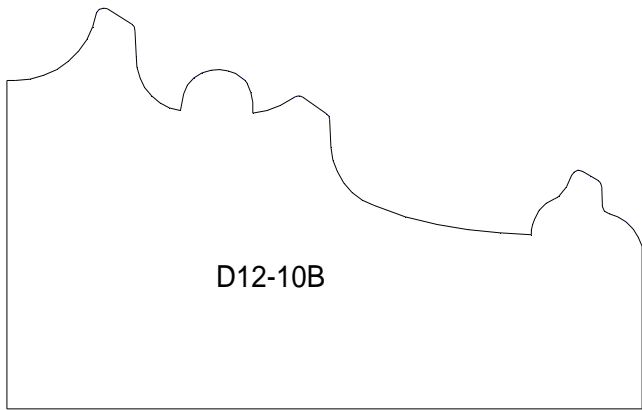

50mm



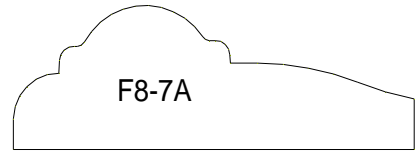
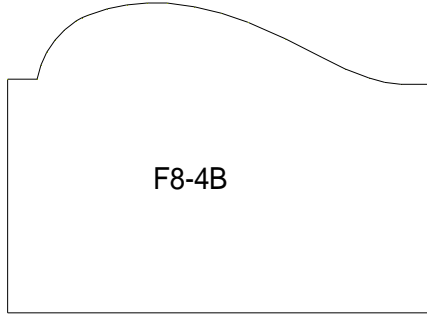
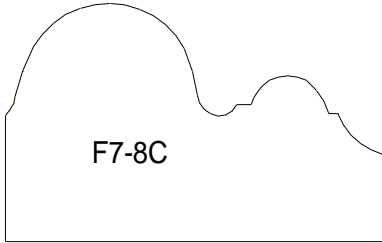
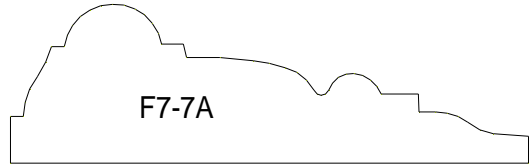
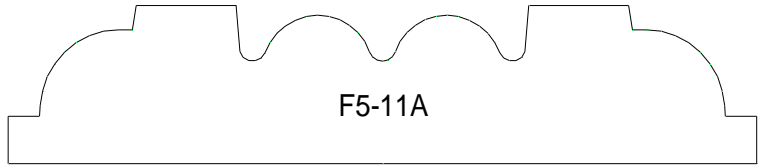
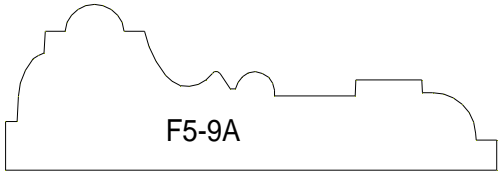

50mm



# Panel Mouldings

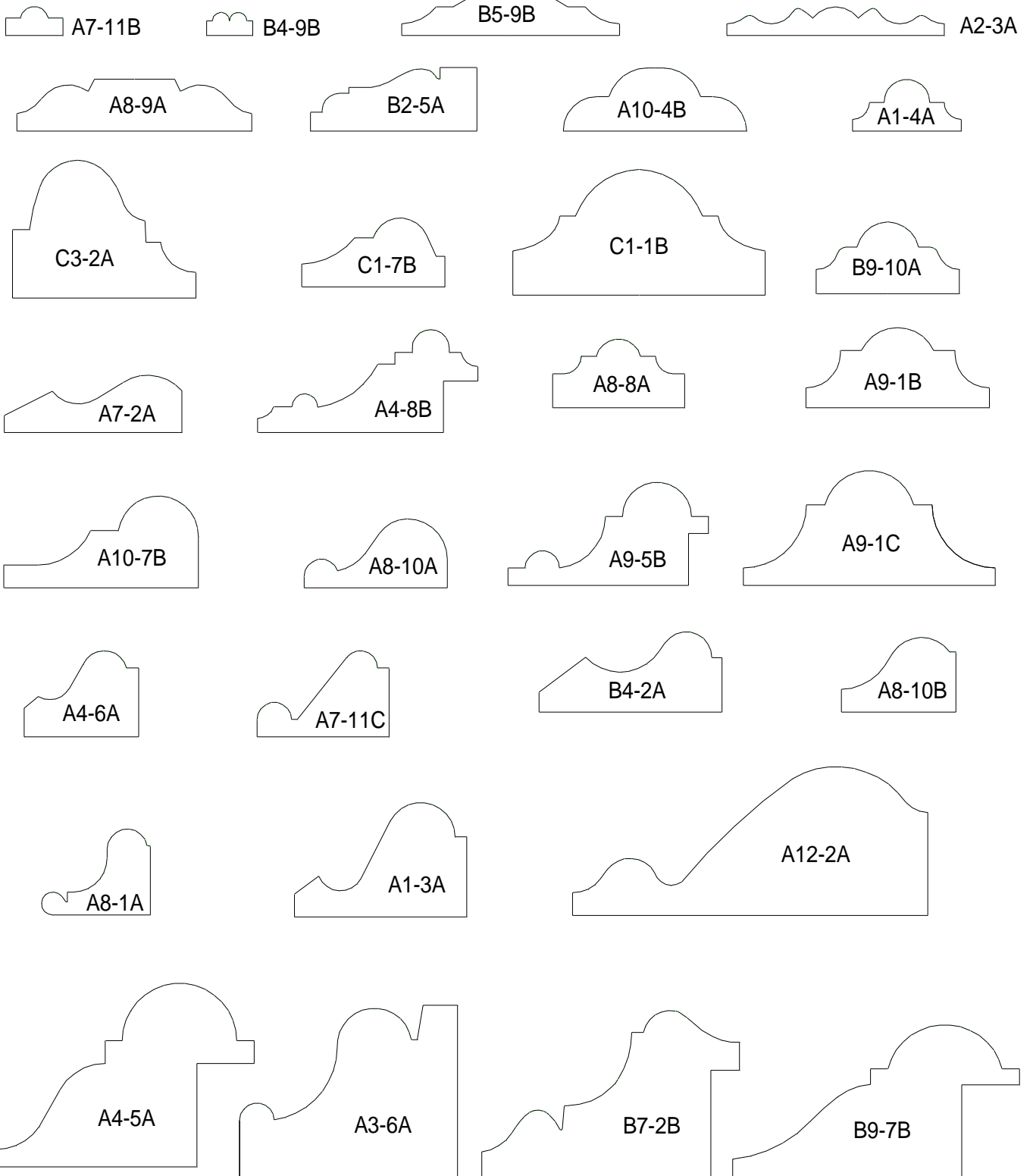

50mm





D2-11A



D3-7A

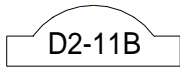

D2-11B

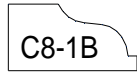

C8-1B



C9-9A

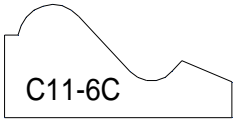

C11-6C

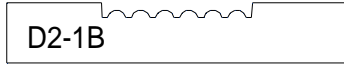

D2-1B

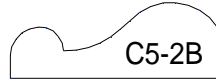

C5-2B



C3-2C

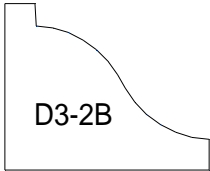

D3-2B

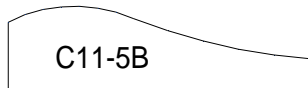

C11-5B

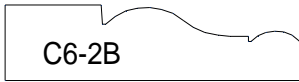

C6-2B

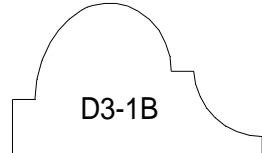

D3-1B

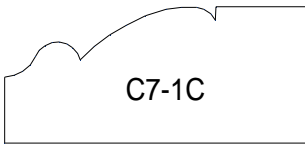

C7-1C

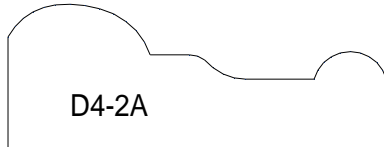

D4-2A

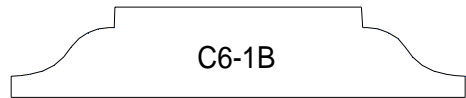

C6-1B

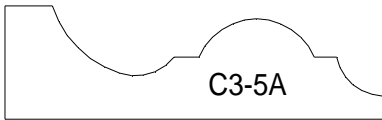

C3-5A



D1-2B

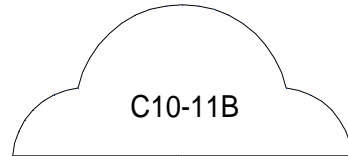

C10-11B



C5-4B

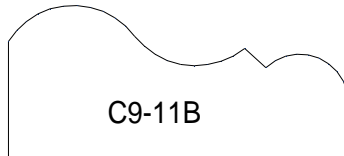

C9-11B

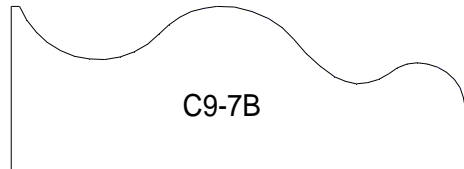

C9-7B

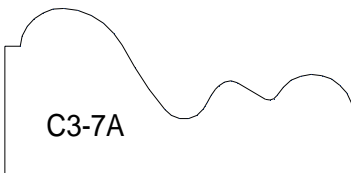

C3-7A

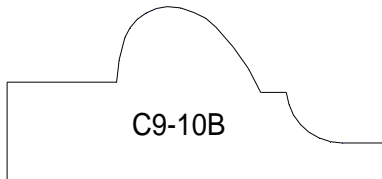

C9-10B

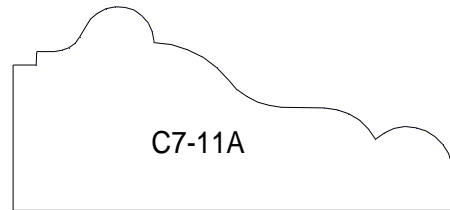

C7-11A

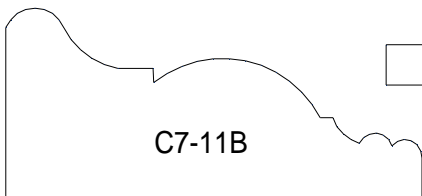

C7-11B

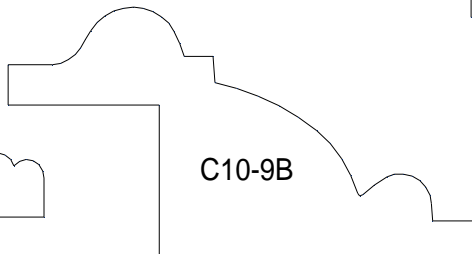

C10-9B



D4-3B

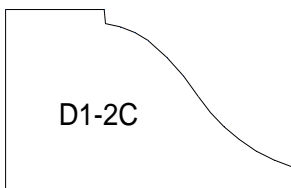

D1-2C

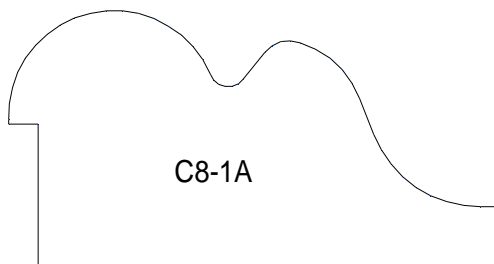

C8-1A

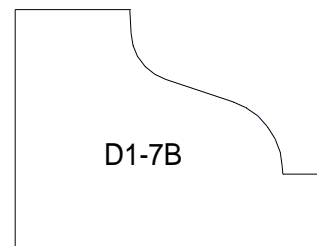

D1-7B

50mm



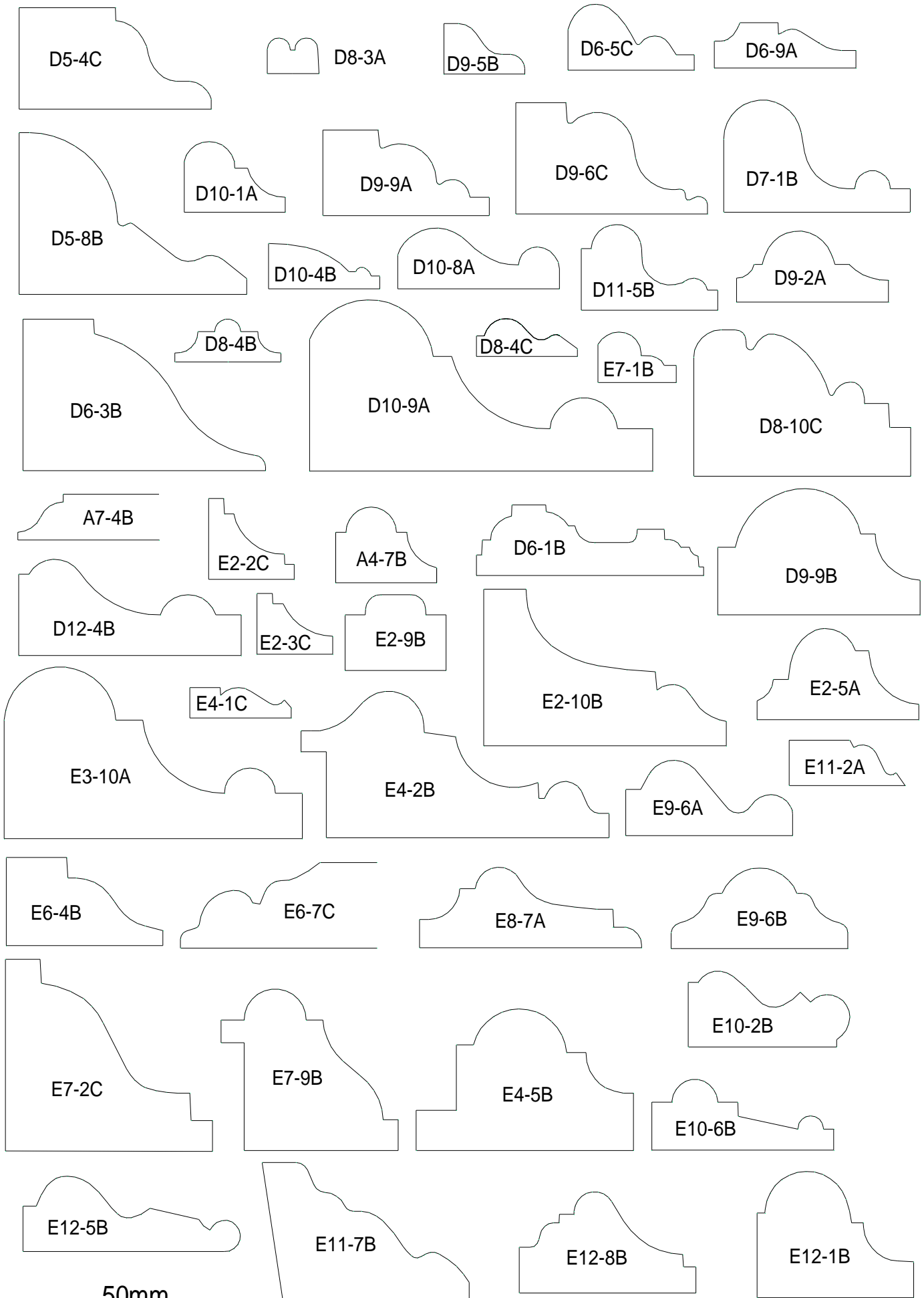

50mm



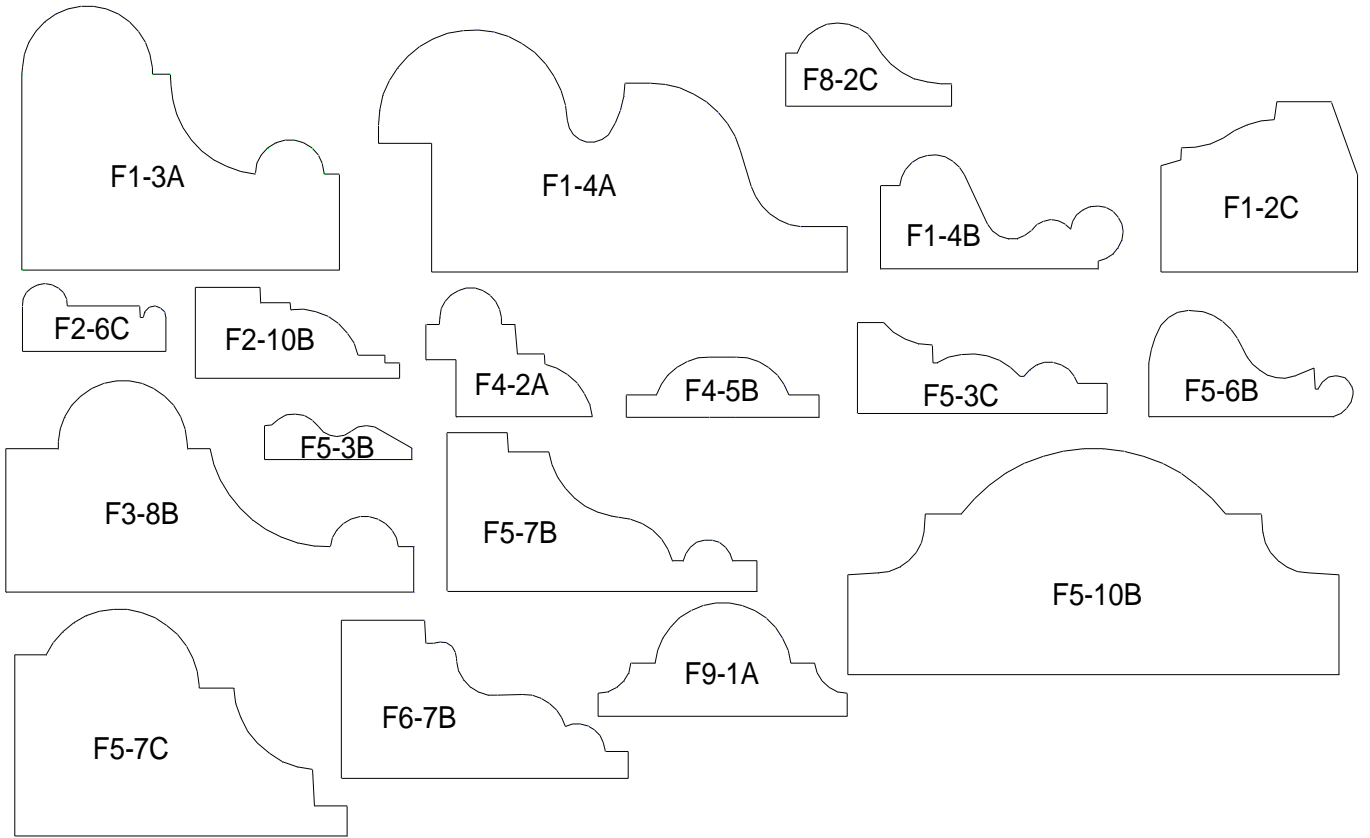

50mm



# Picture Rail

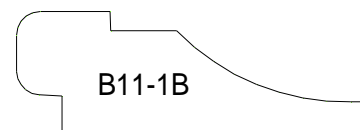
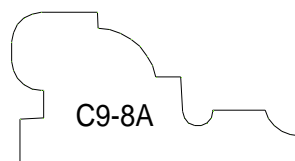
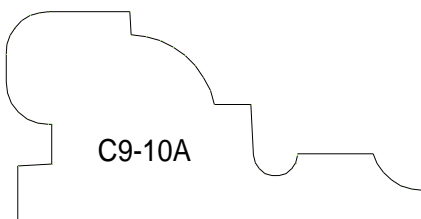
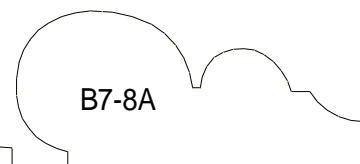
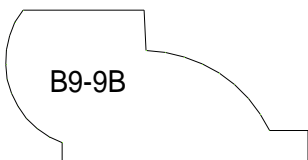
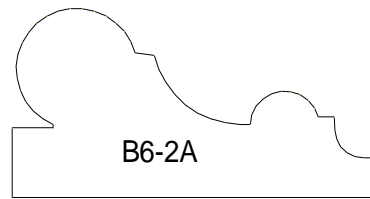
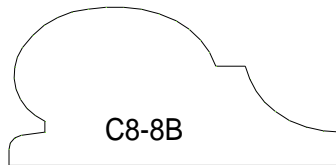
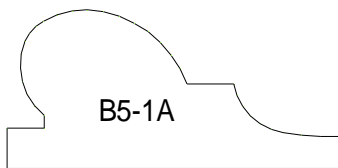
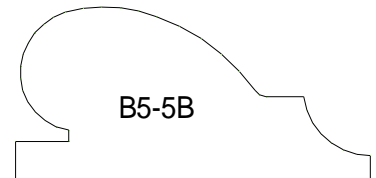
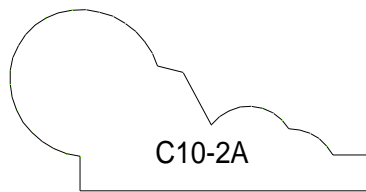
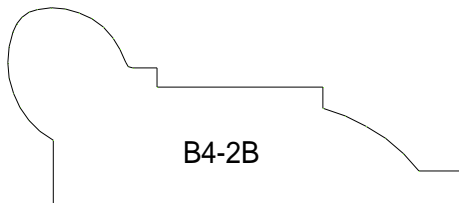
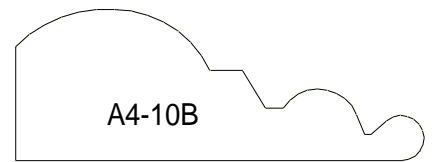
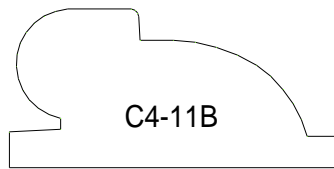
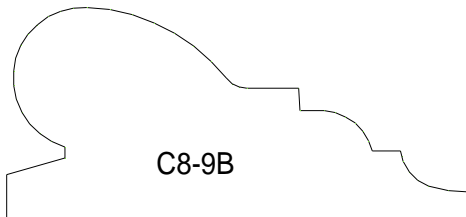
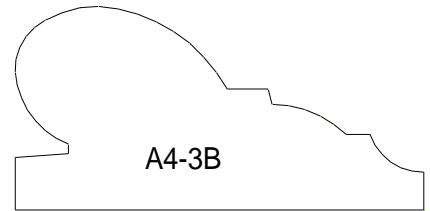
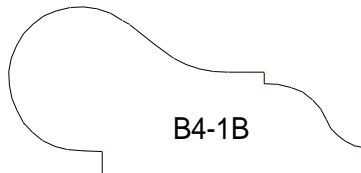
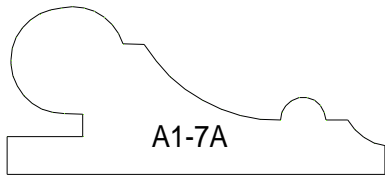
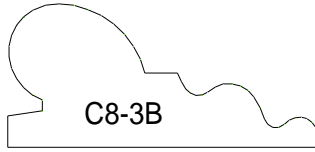
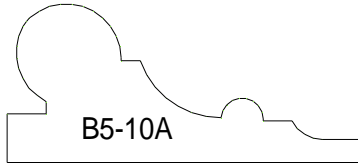
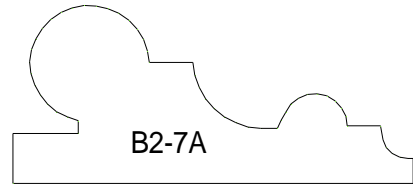
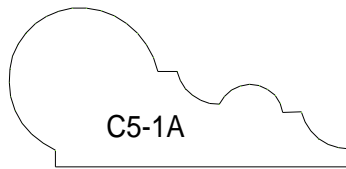
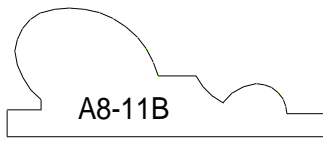

50mm



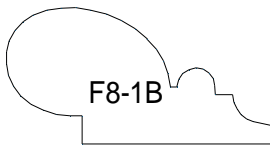
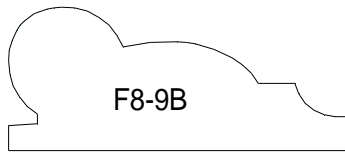
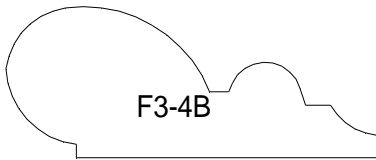
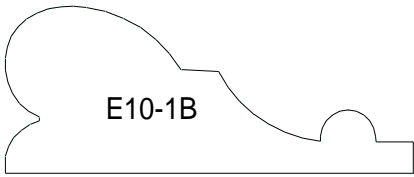
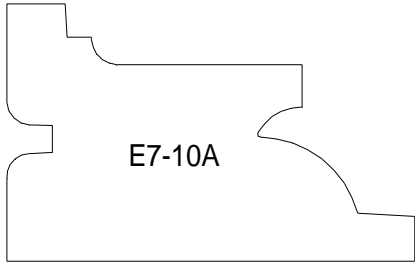
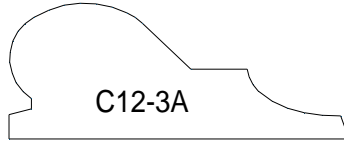
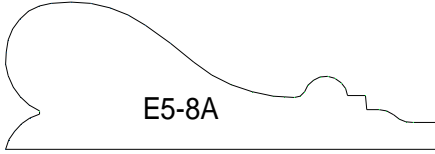
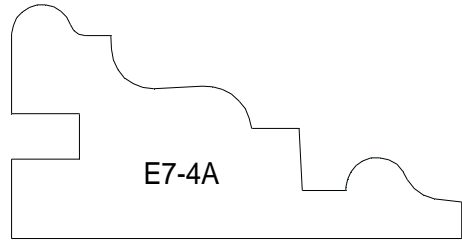
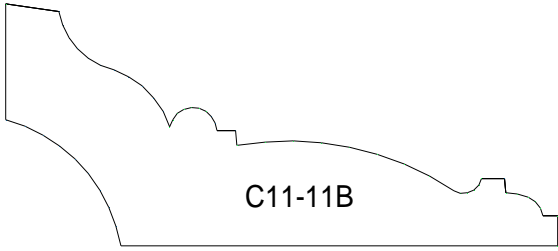

50mm



# Cornice

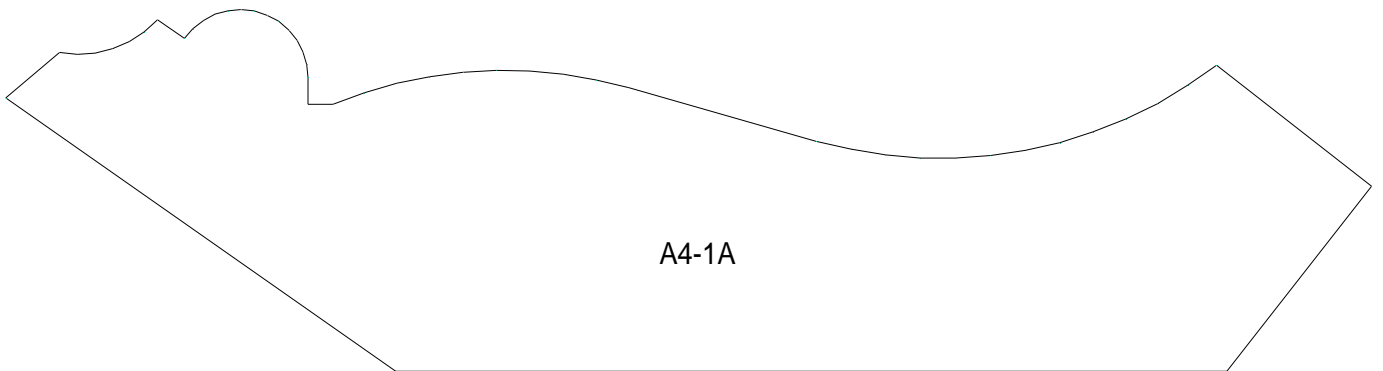
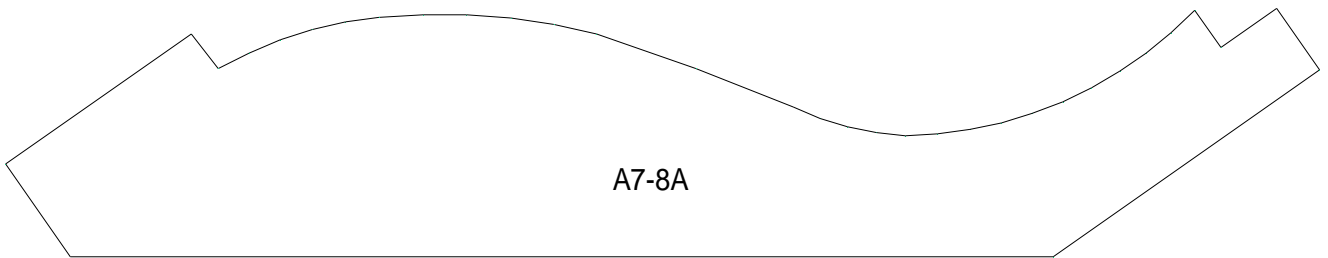
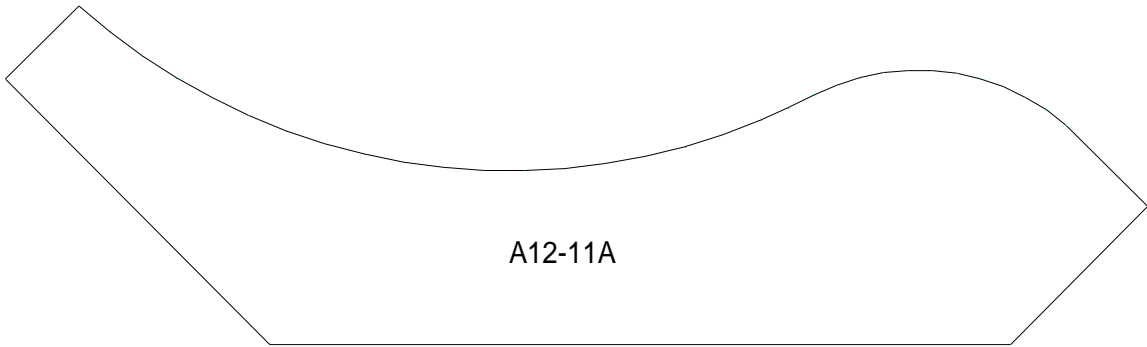
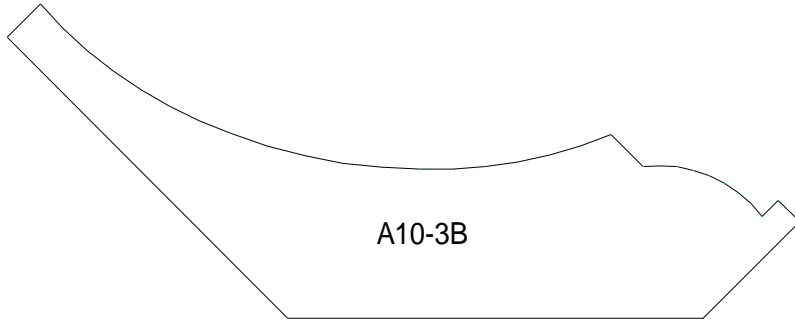
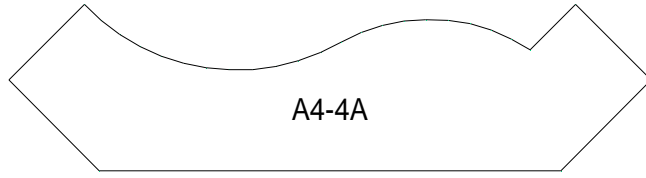

50mm



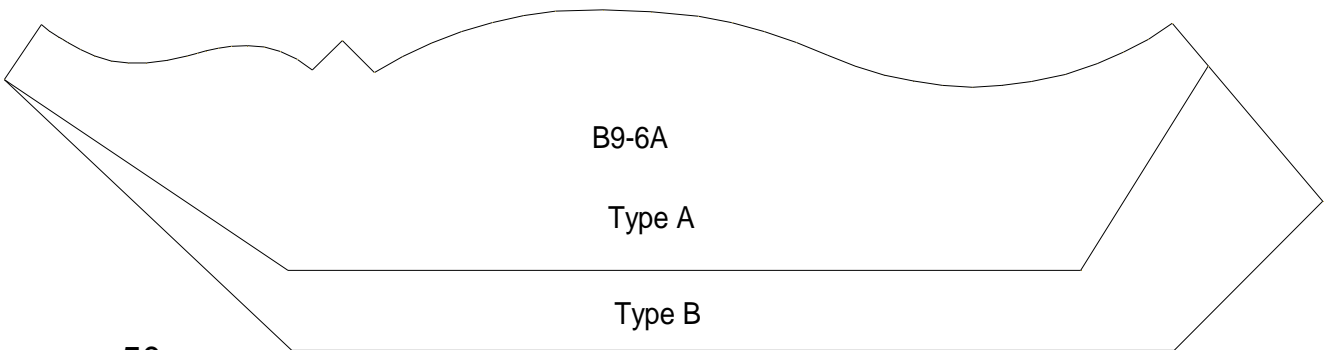
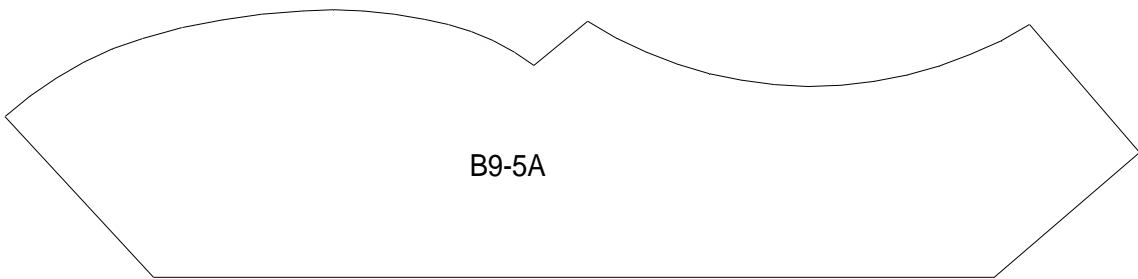
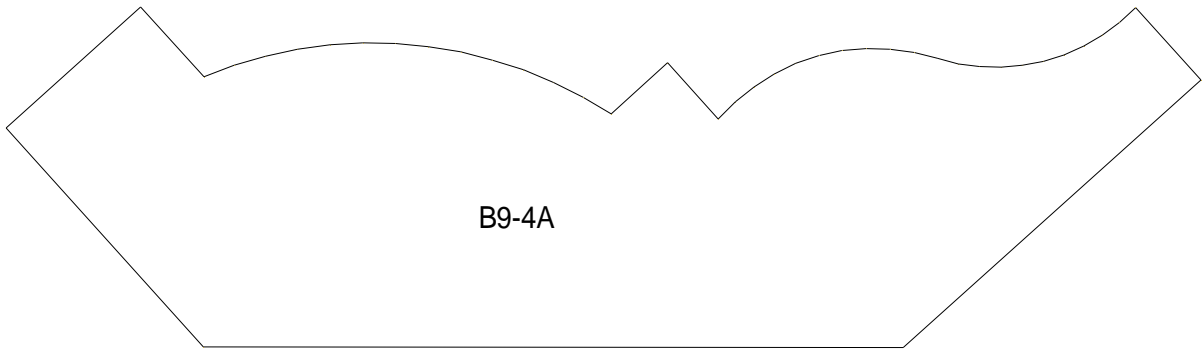
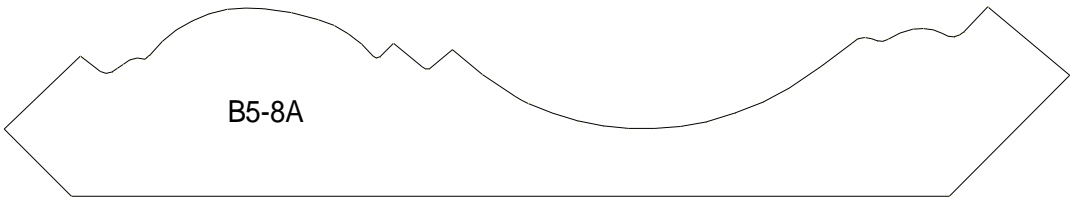
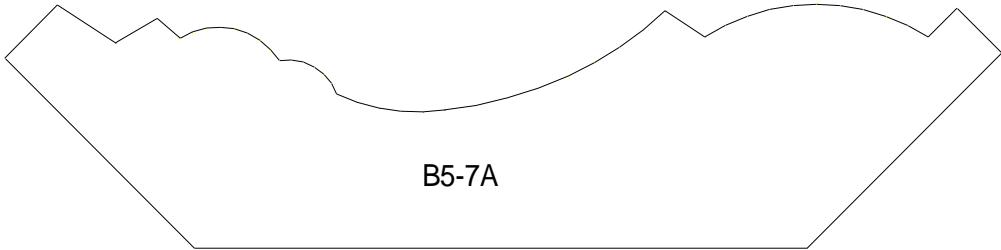

50mm



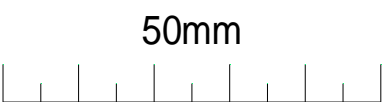
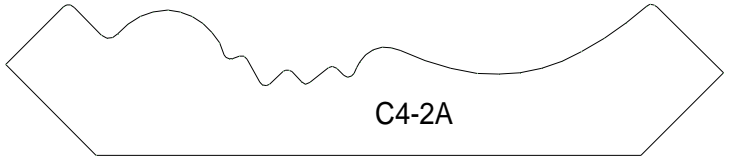
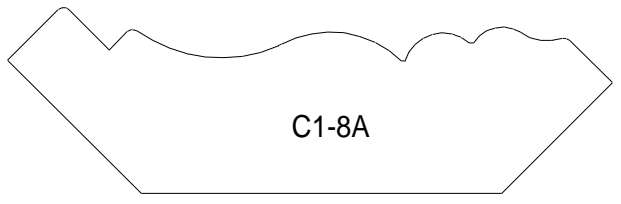
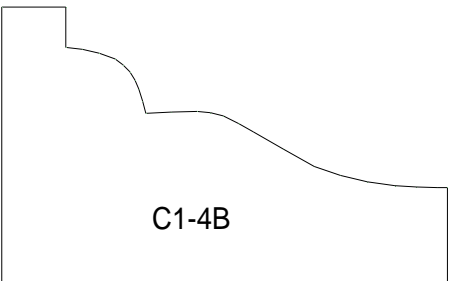
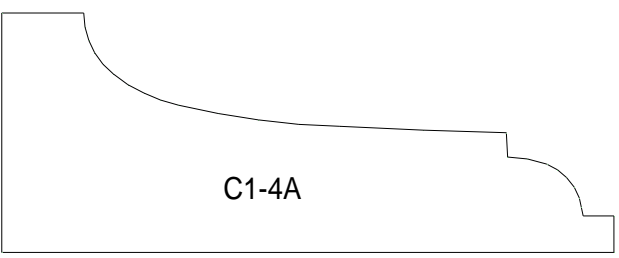
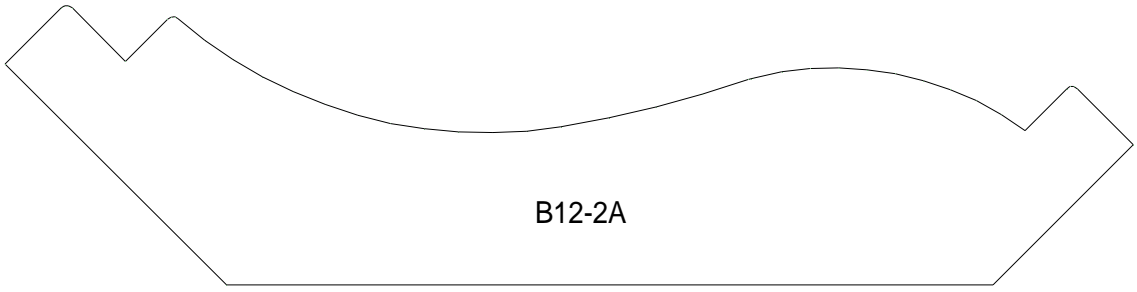
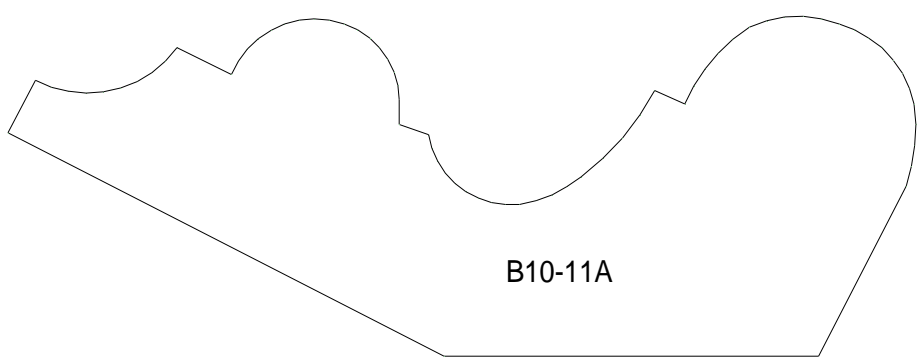
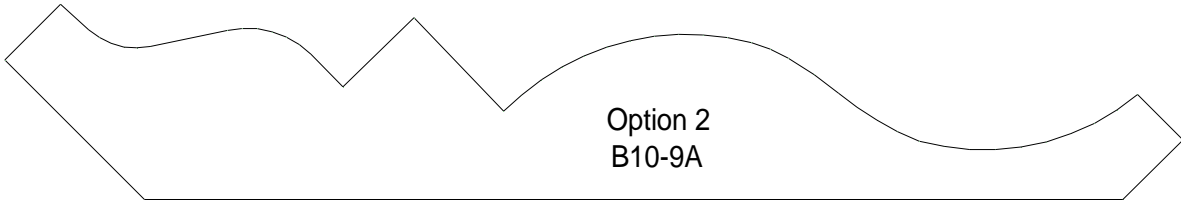
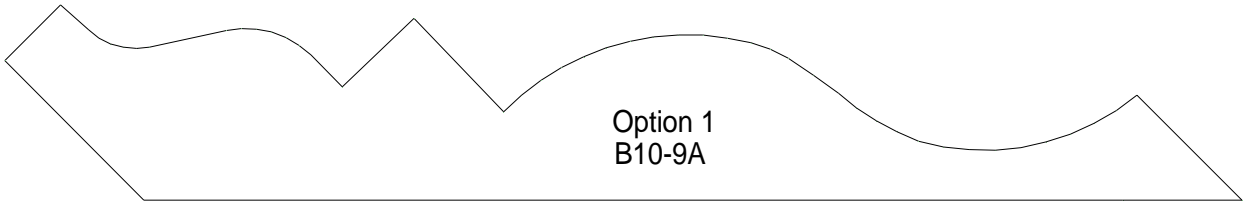

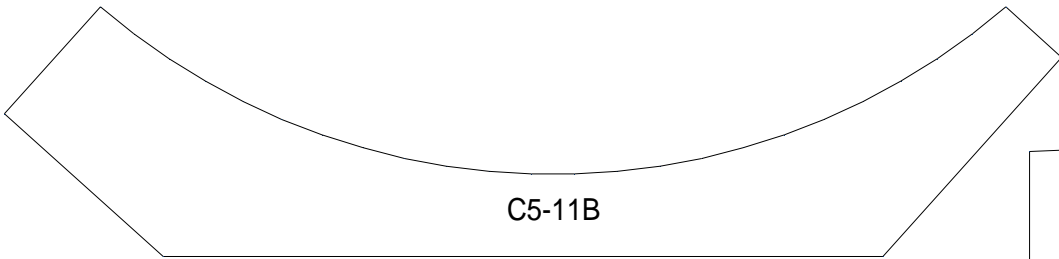
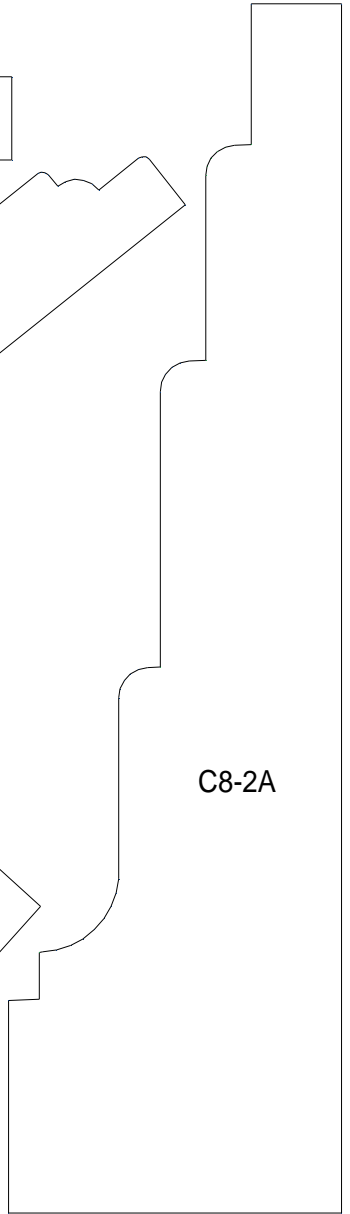
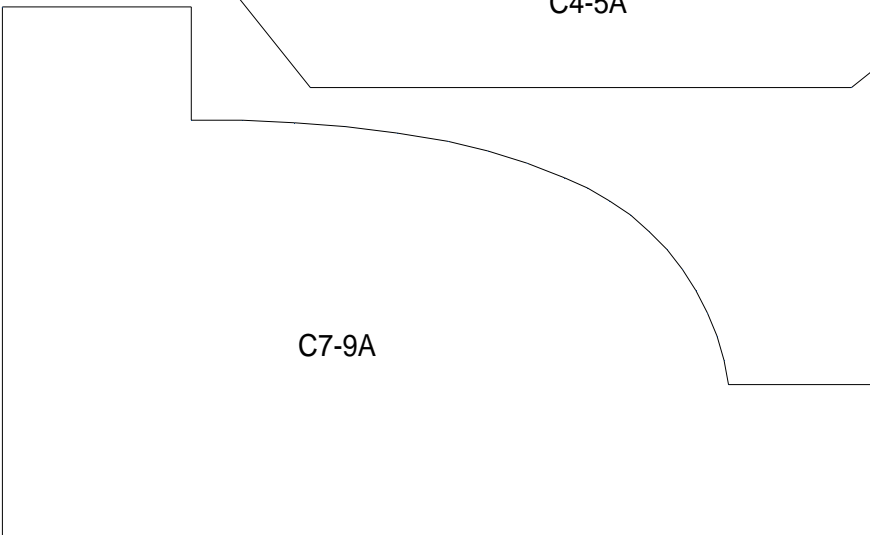
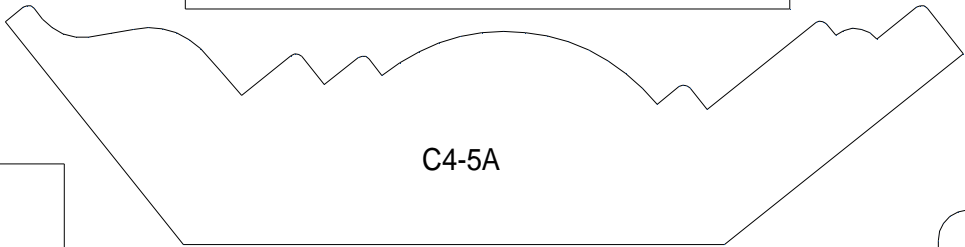
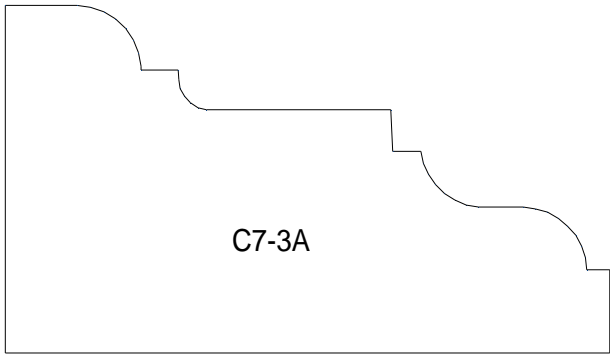
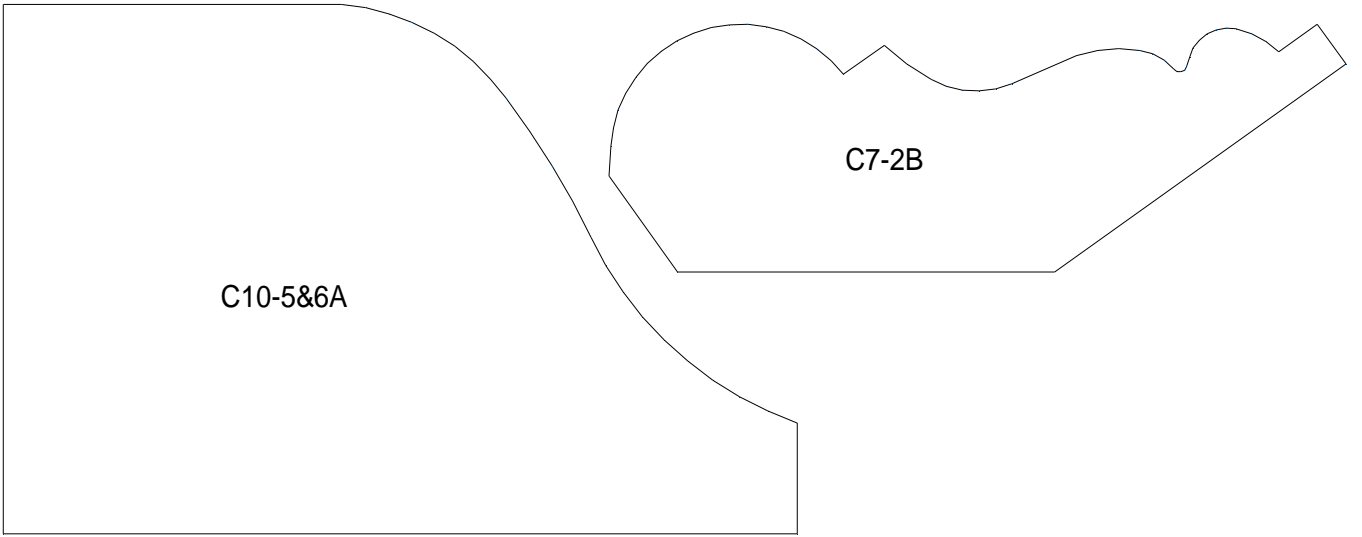

50mm



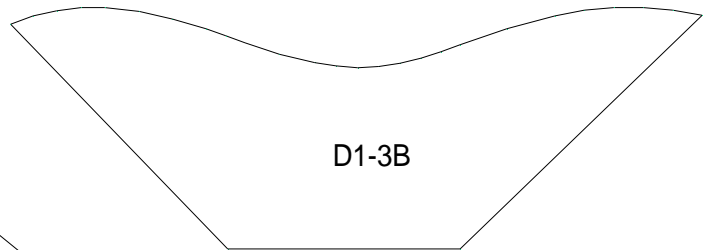
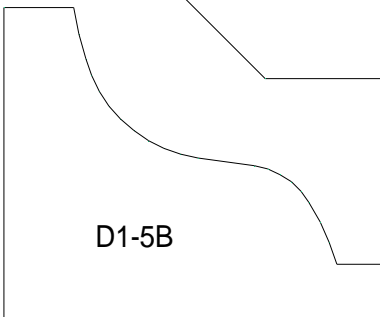
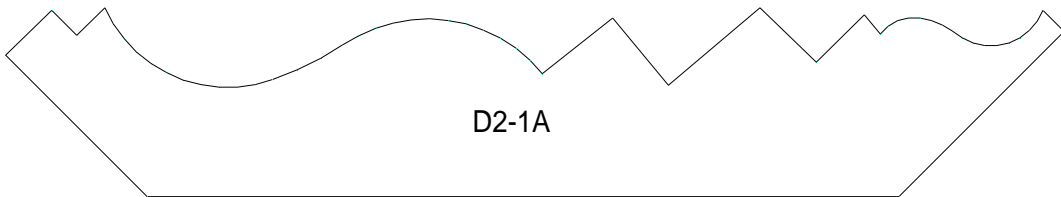
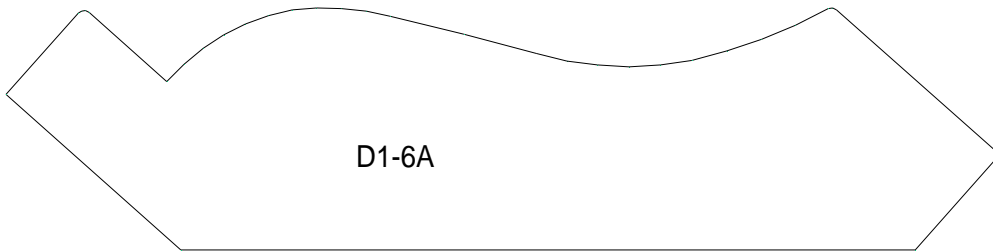
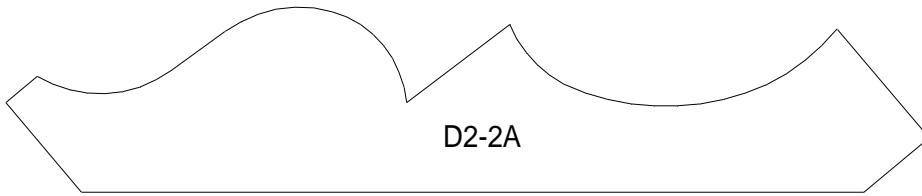
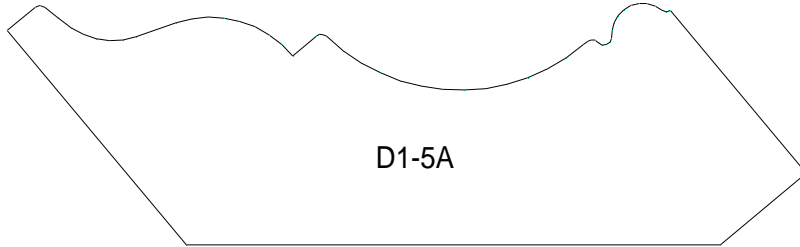
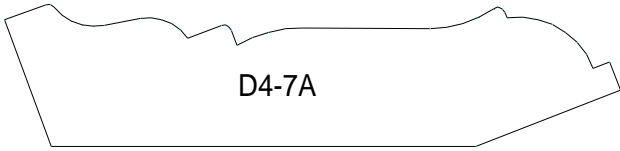

50mm



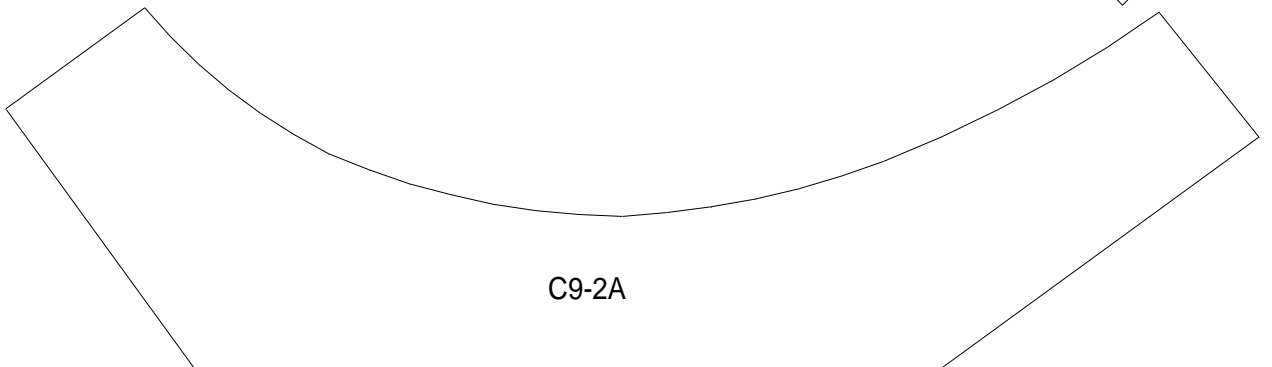
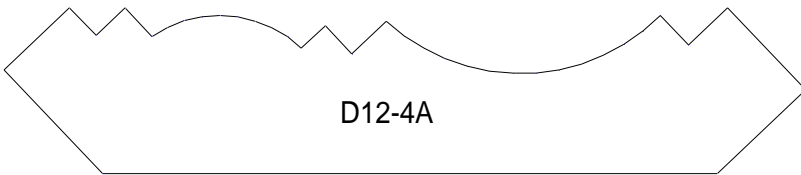
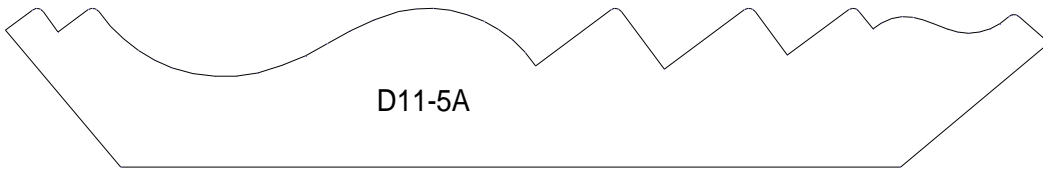
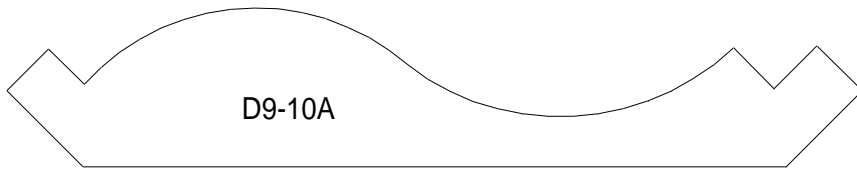
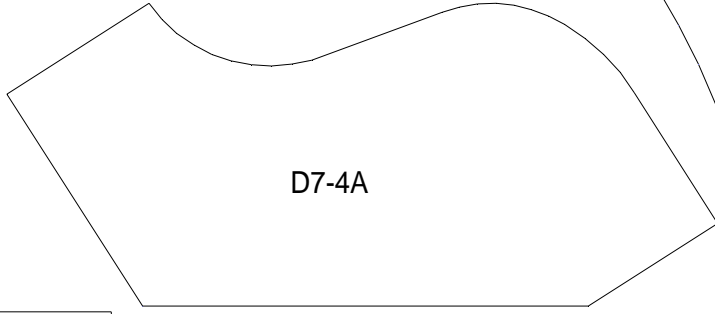
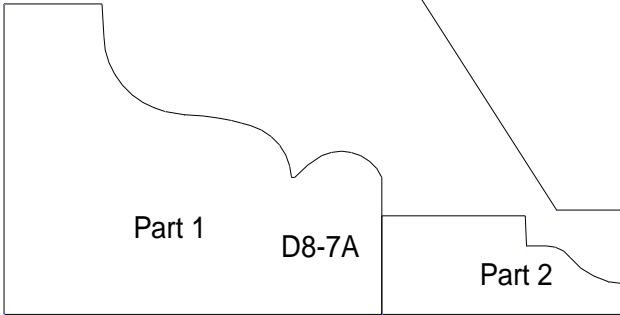
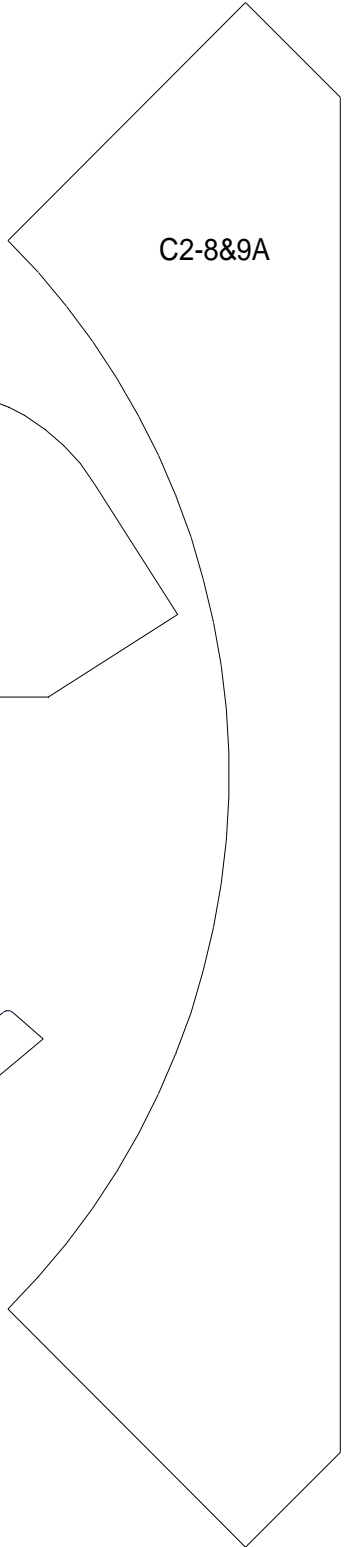
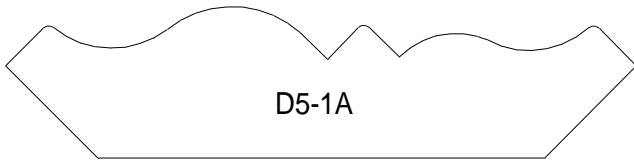
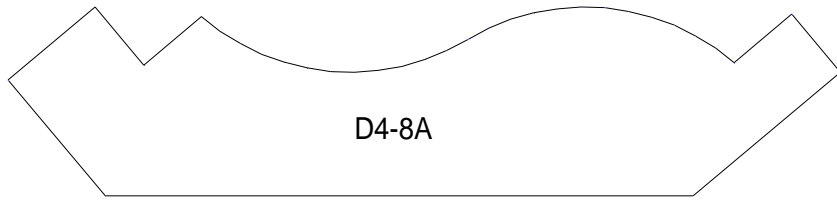

50mm



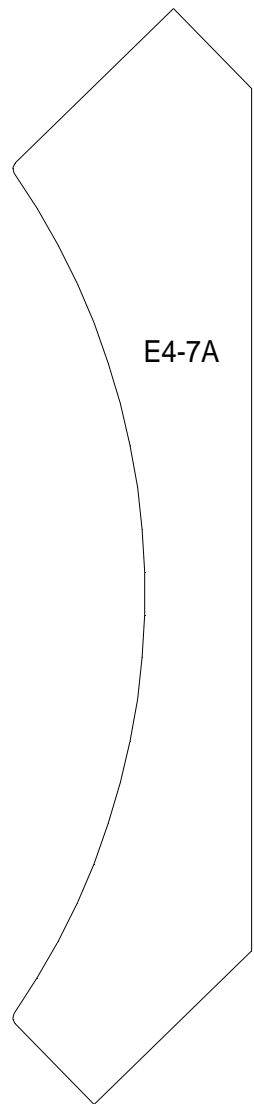
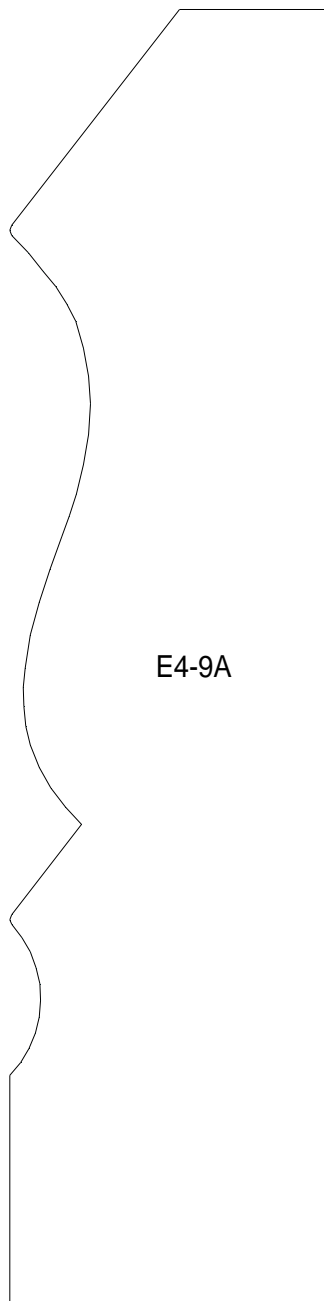
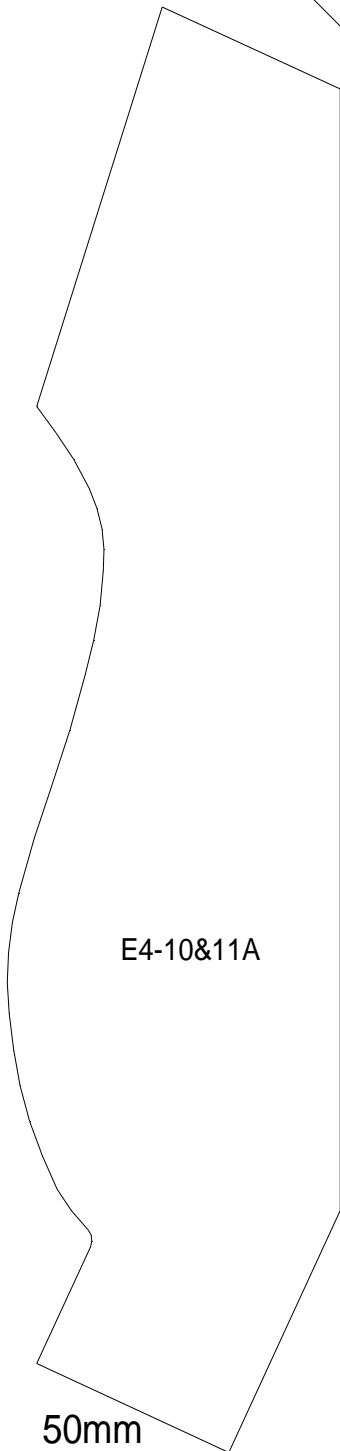
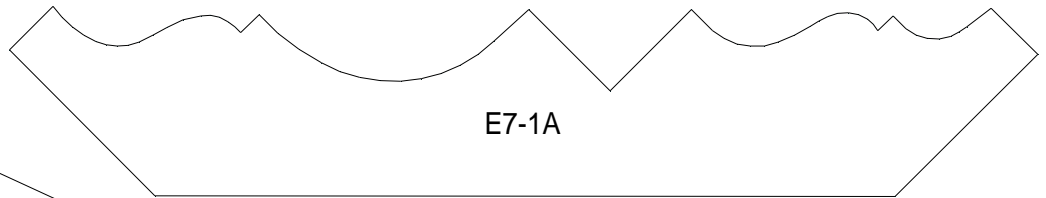
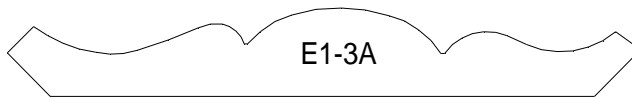
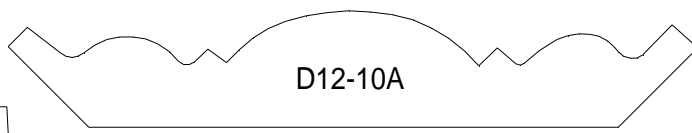
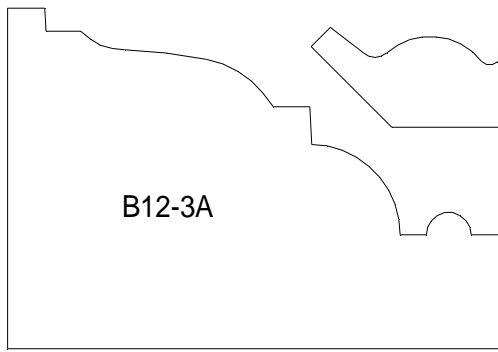

50mm



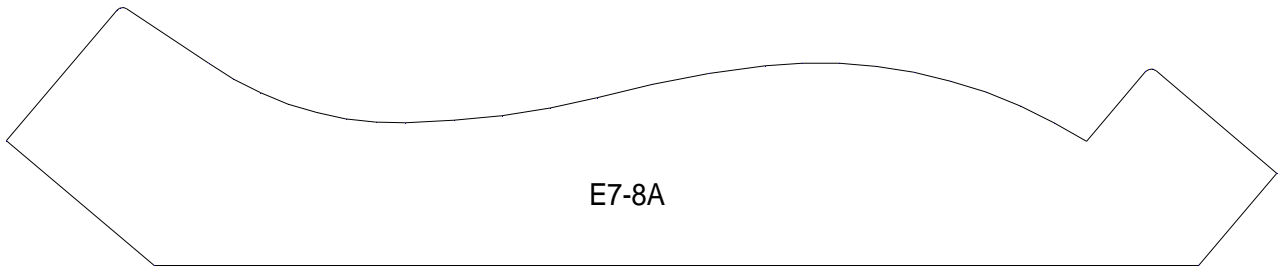

E7-8A

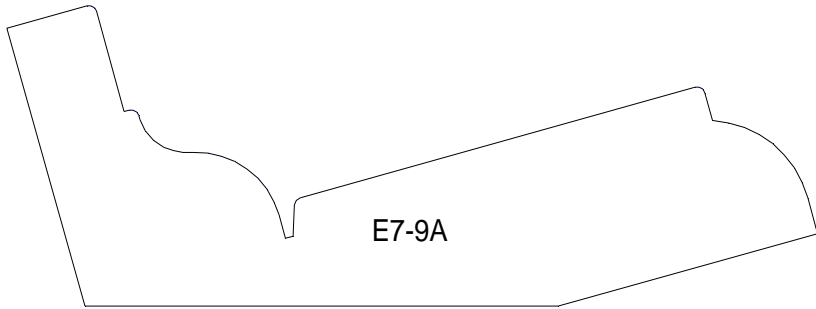

E7-9A

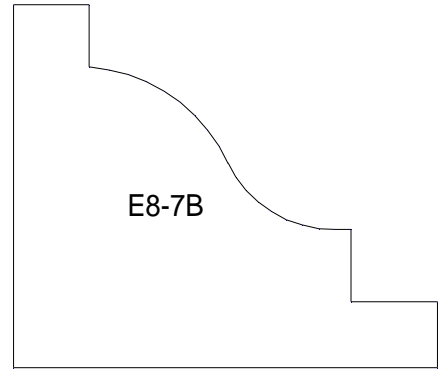

E8-7B

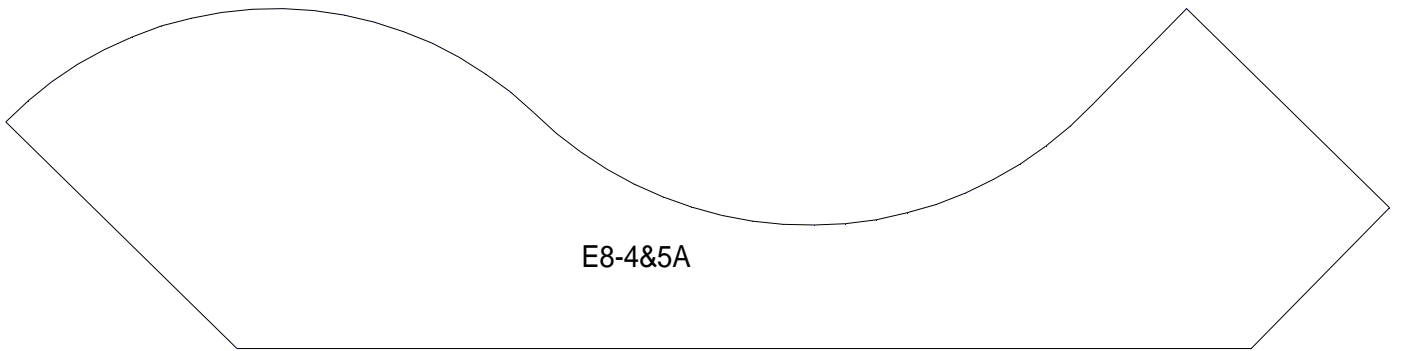

E8-4&5A

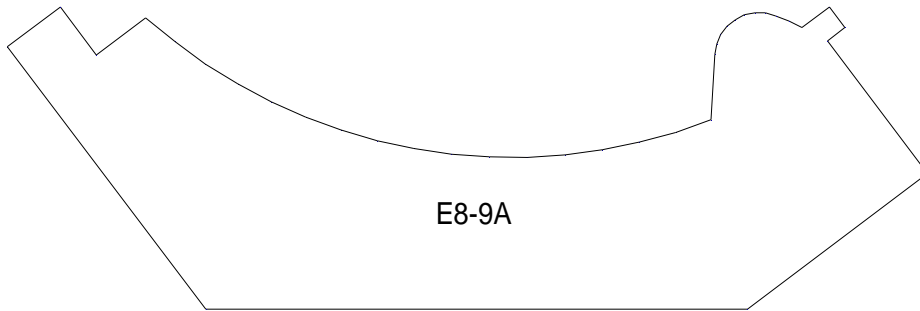

E8-9A

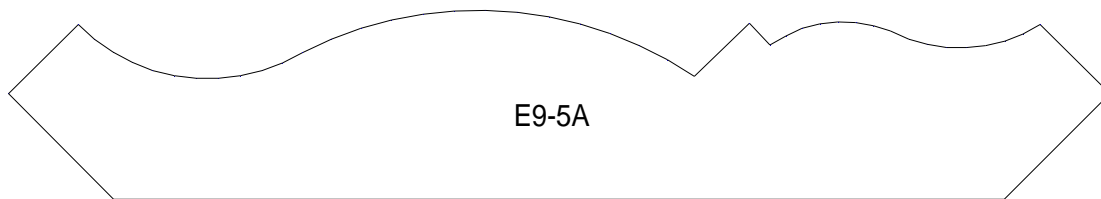

E9-5A

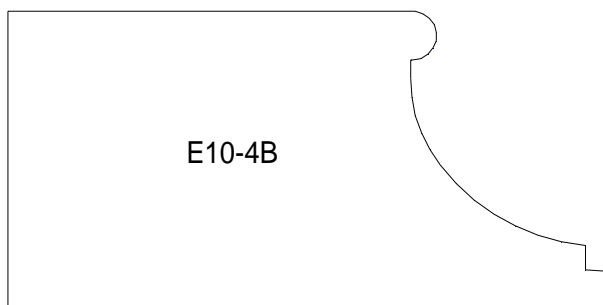

E10-4B

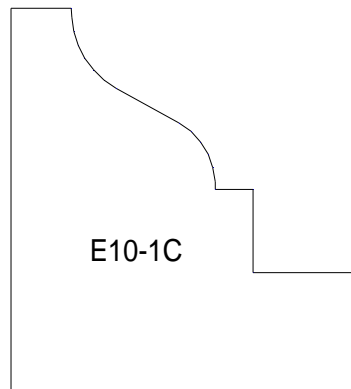

E10-1C

50mm



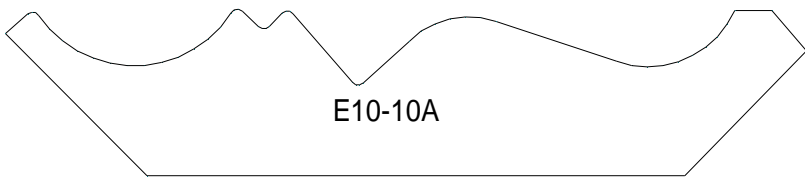

E10-10A

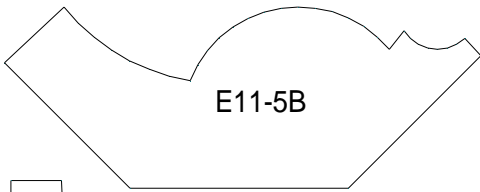

E11-5B

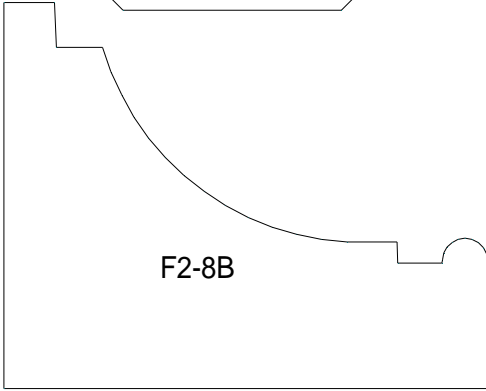

F2-8B

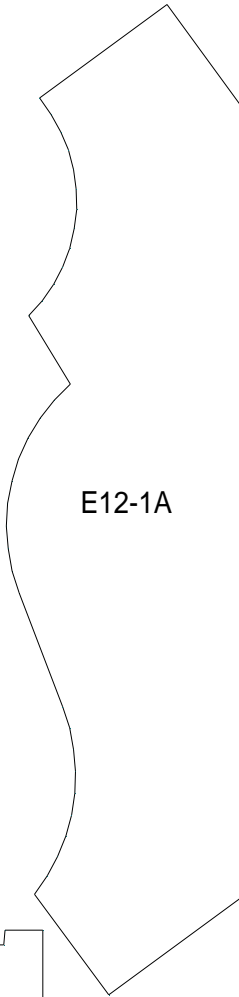

E12-1A

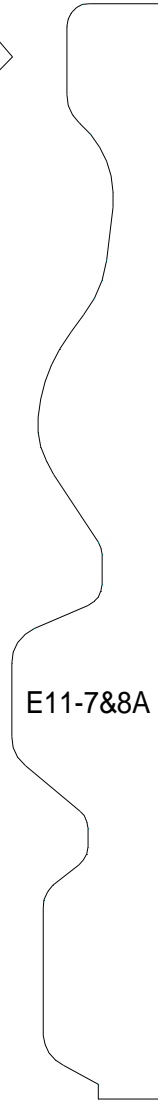

E11-7&8A

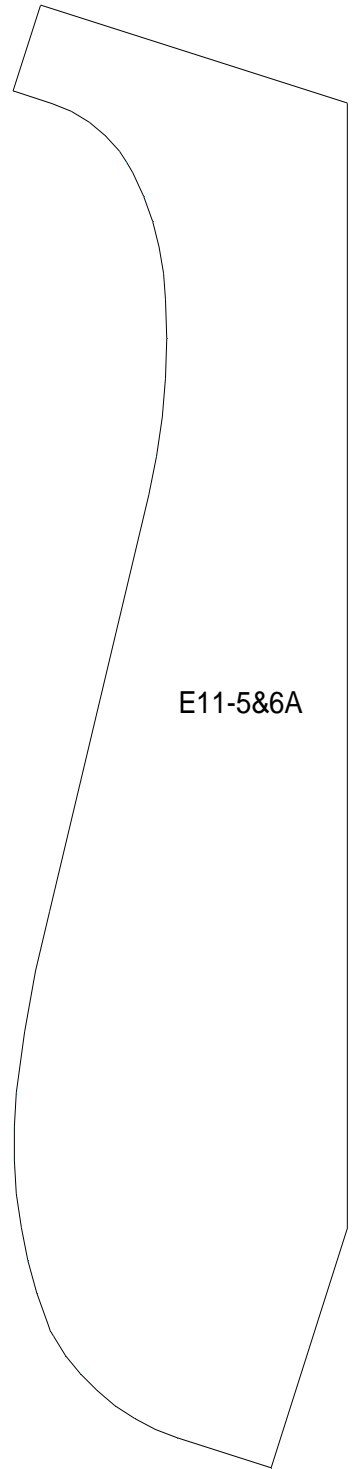

E11-5&6A

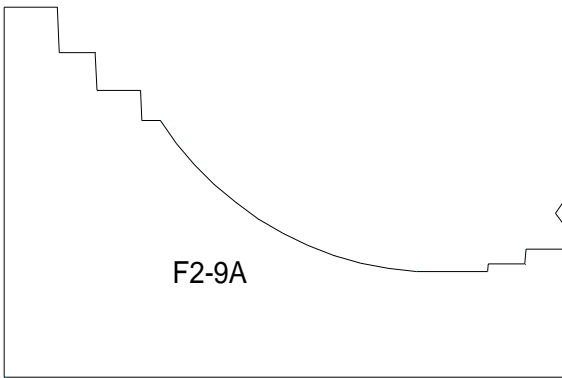

F2-9A

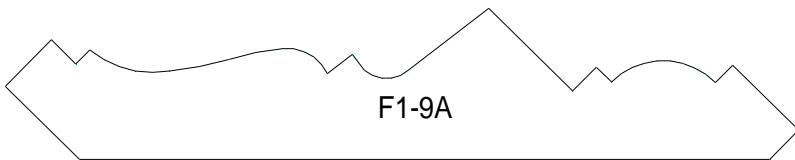

F1-9A

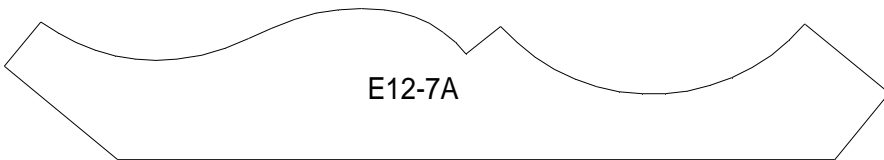

E12-7A

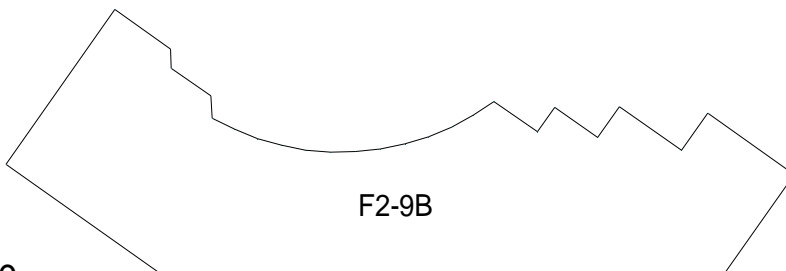

F2-9B

50mm



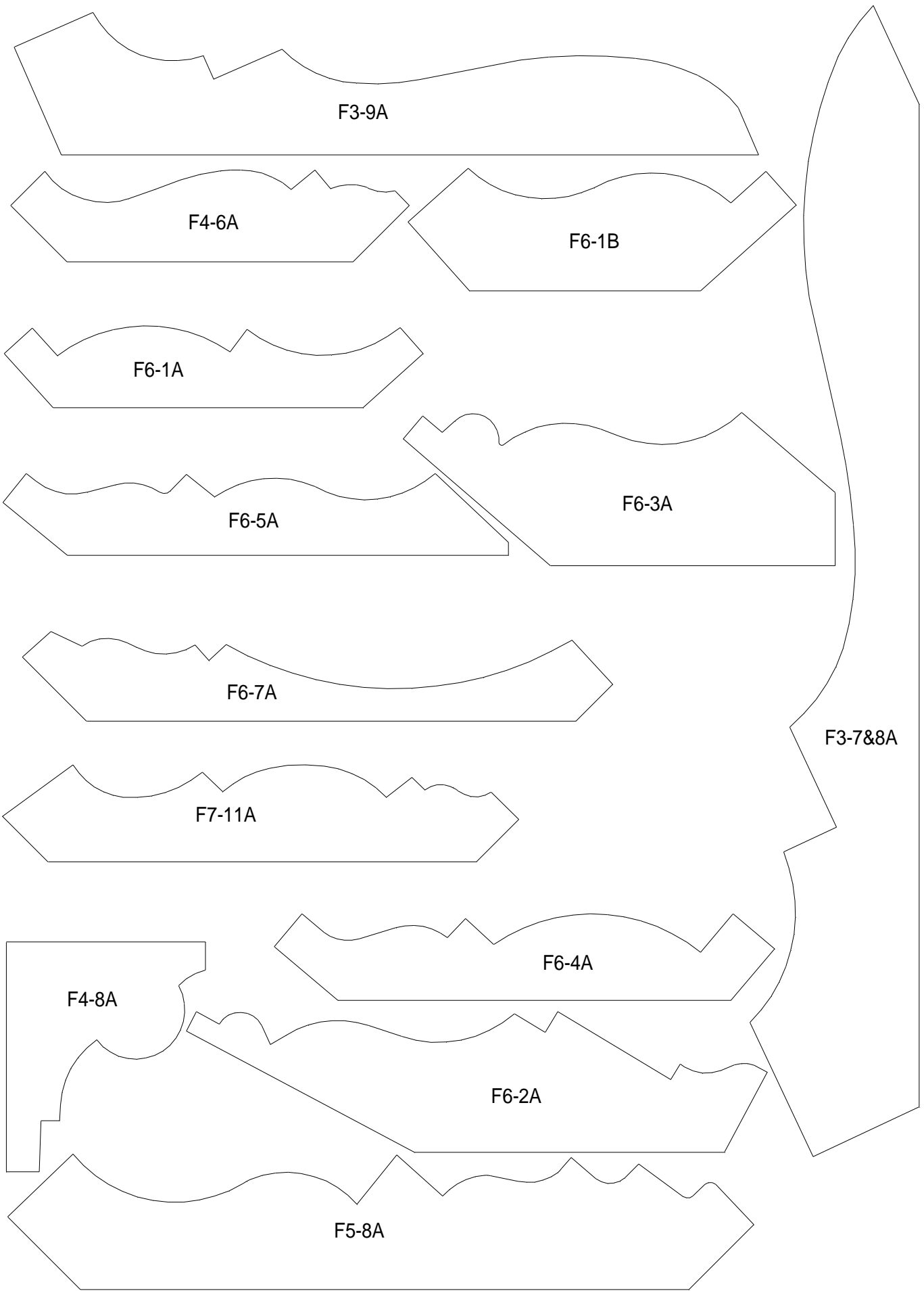

50mm



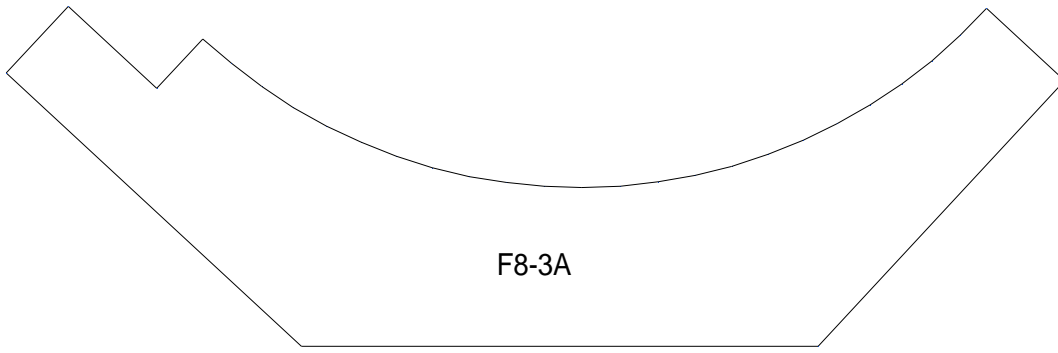

F8-3A

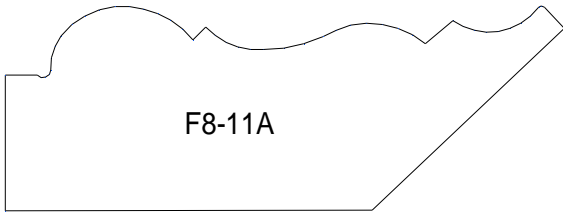

F8-11A

50mm



# Handrail

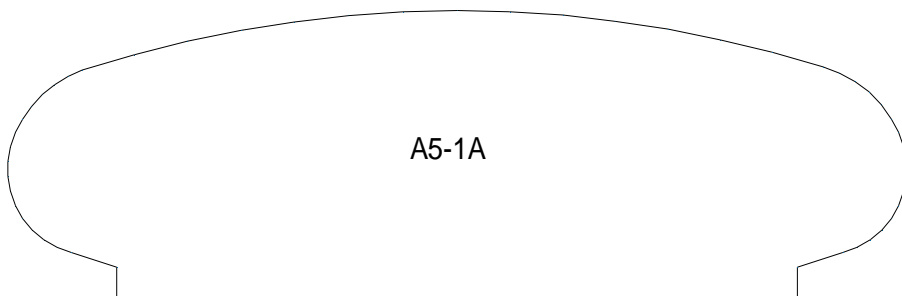
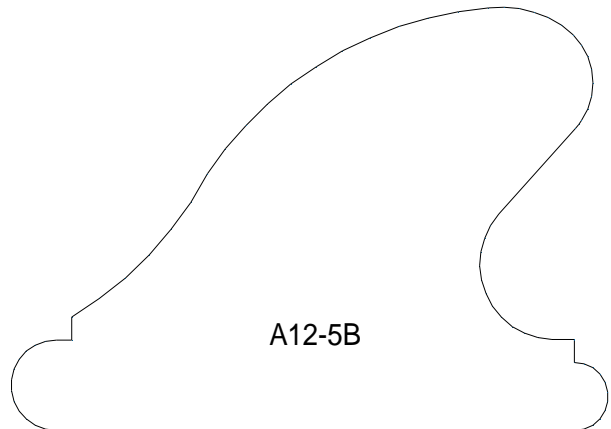
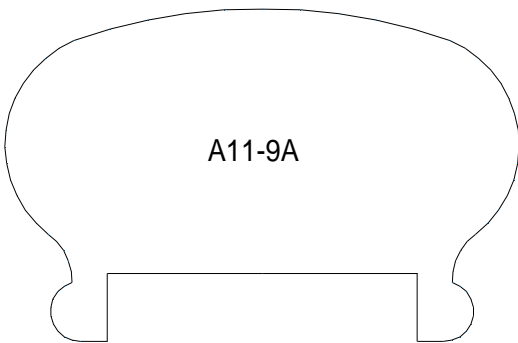
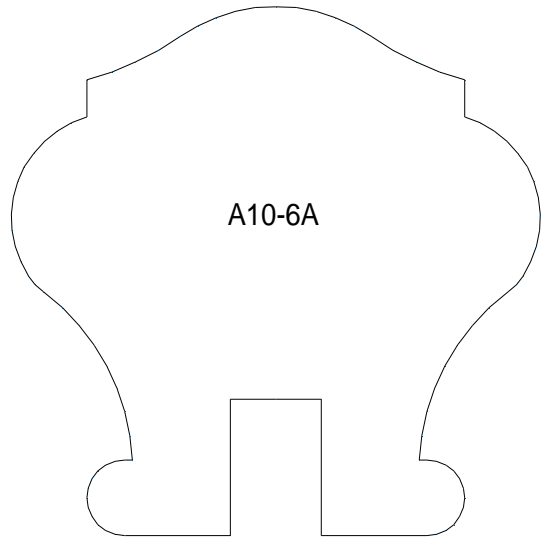
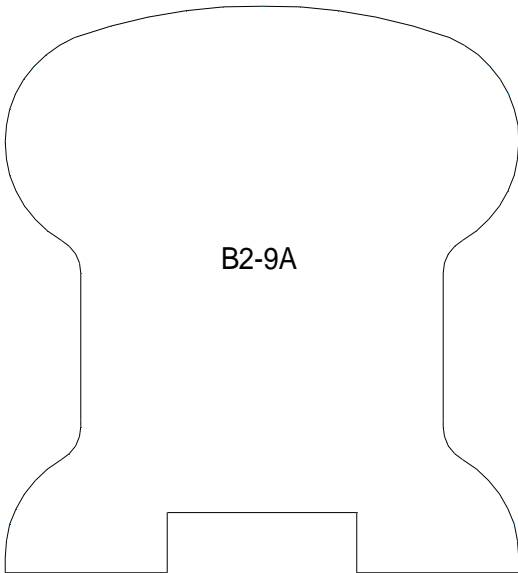
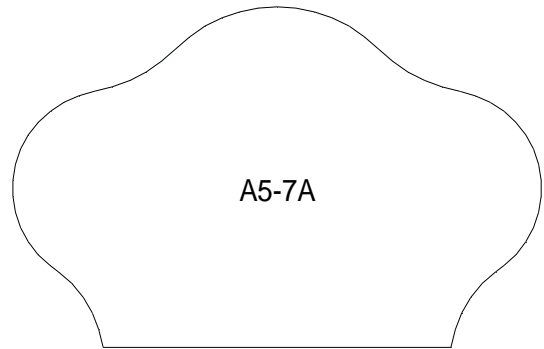
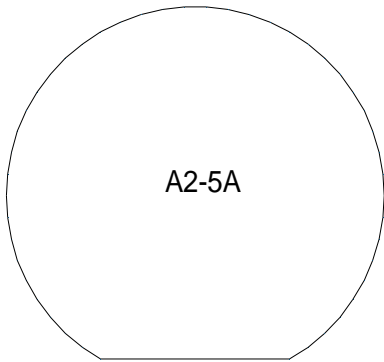

50mm



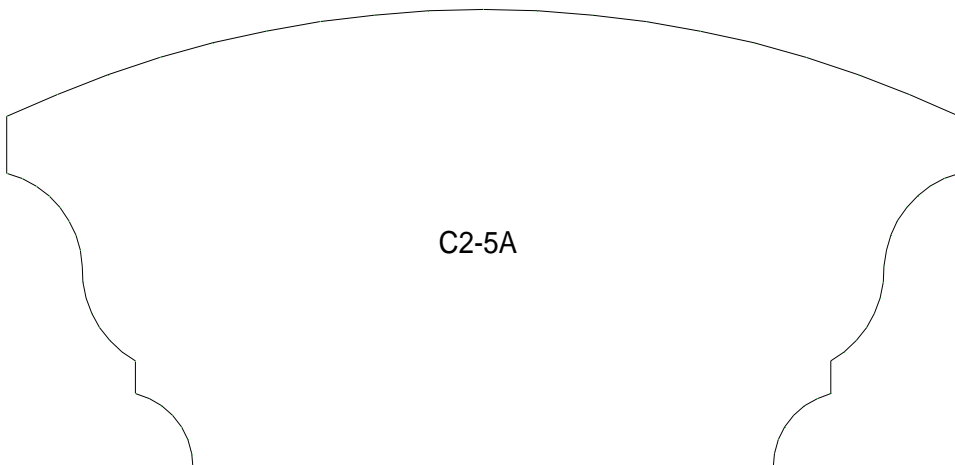
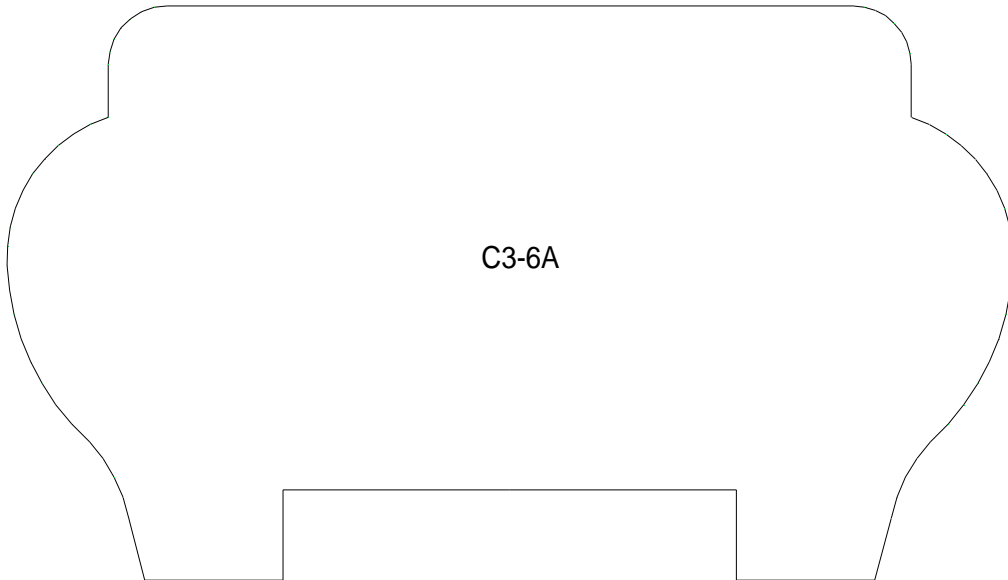
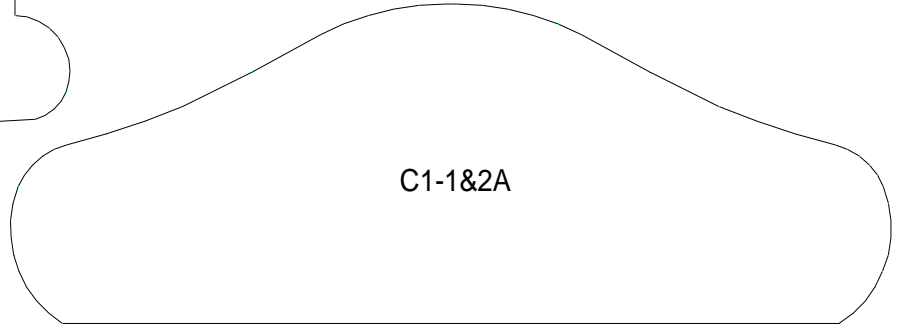
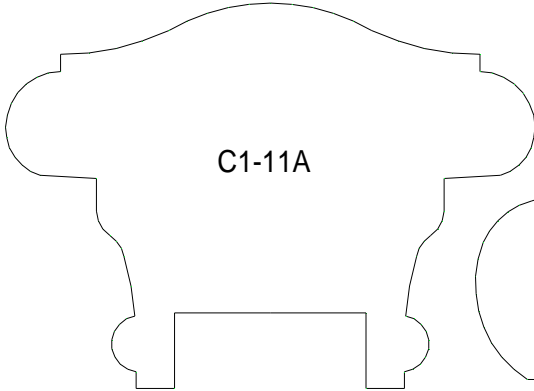
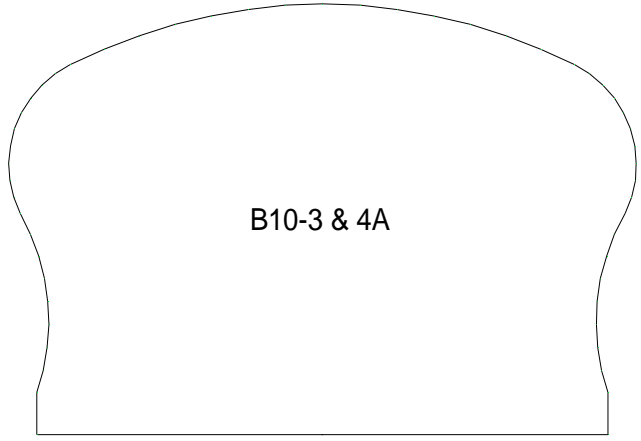
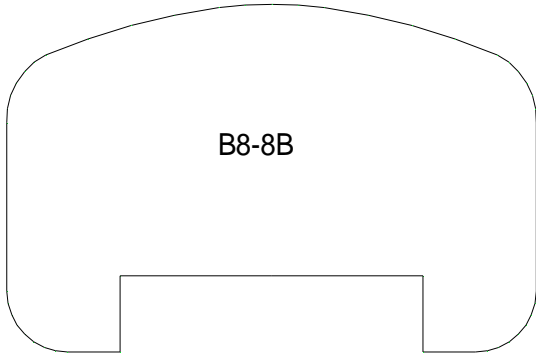

50mm



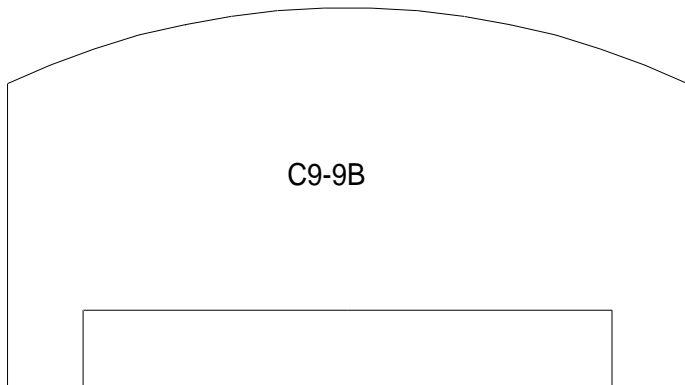
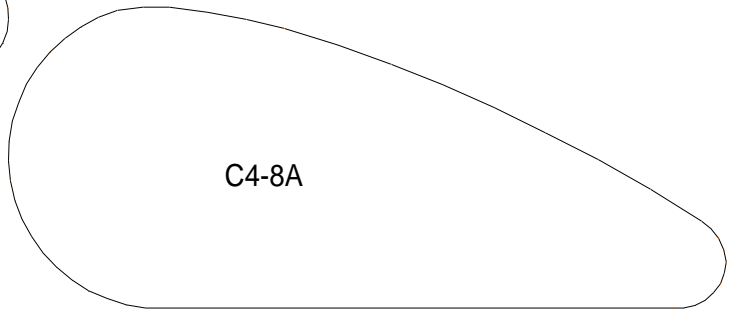
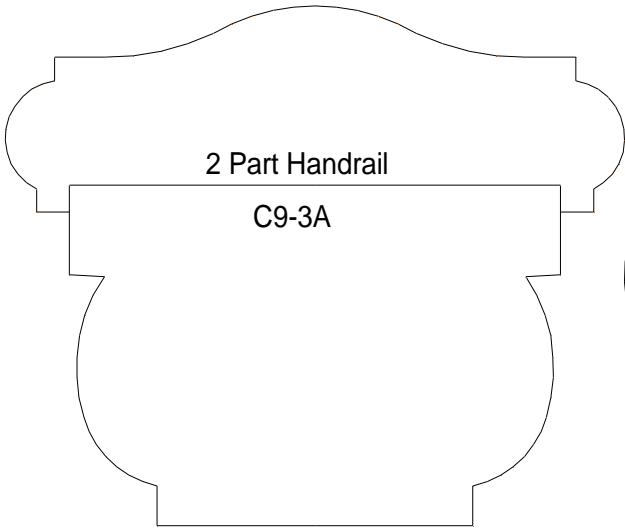
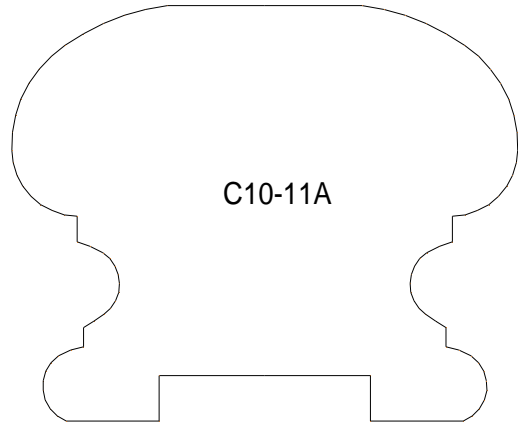
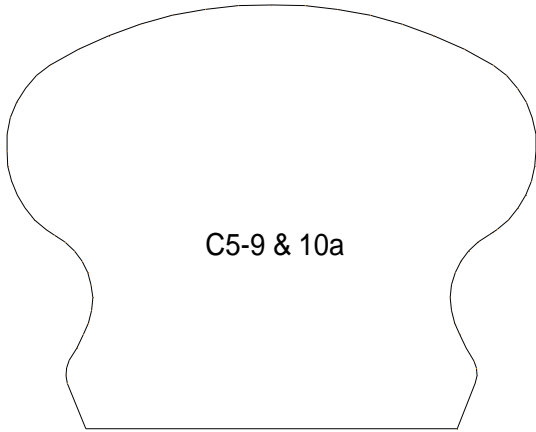
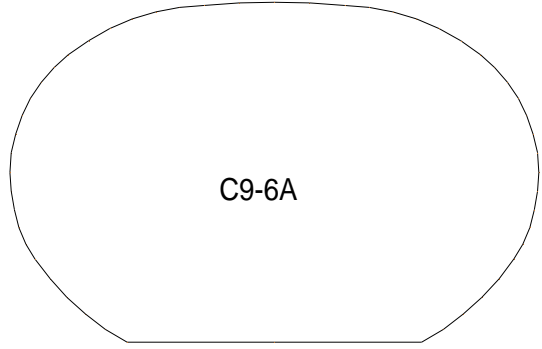
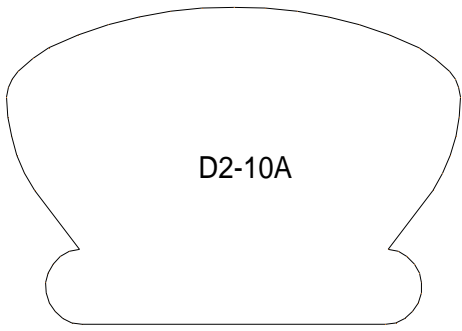

50mm



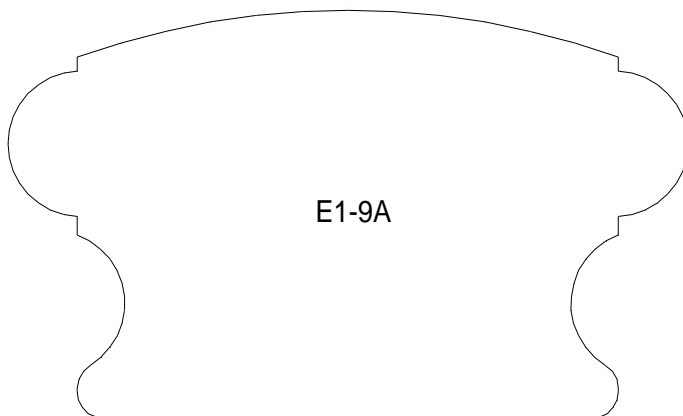
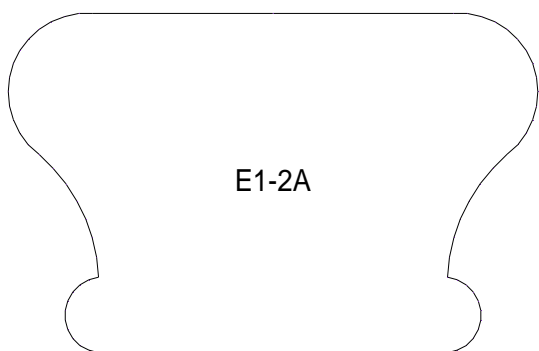
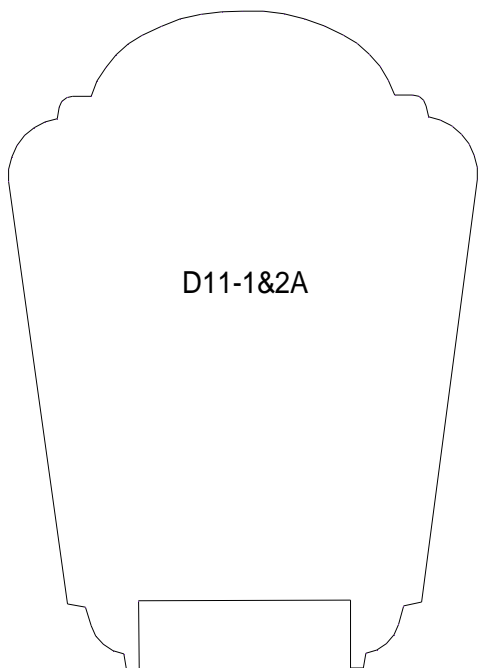
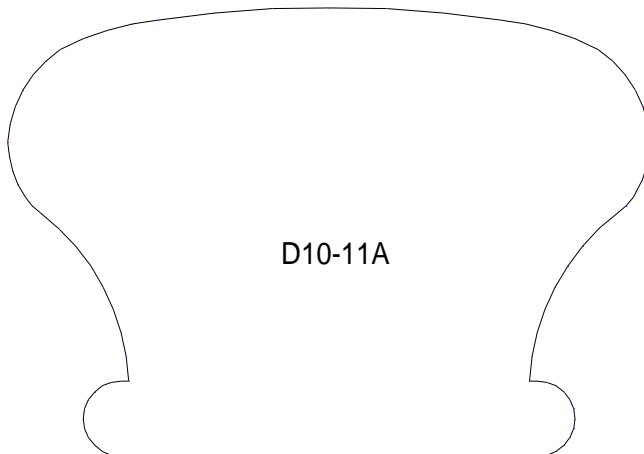
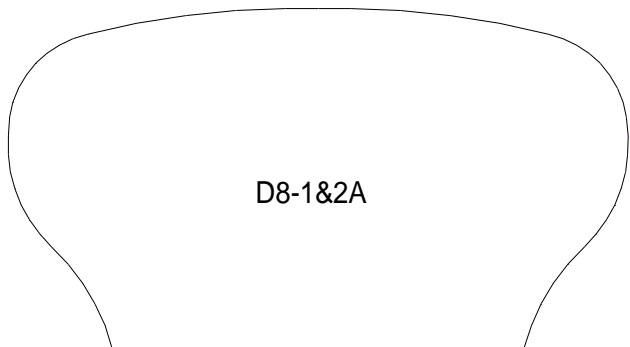
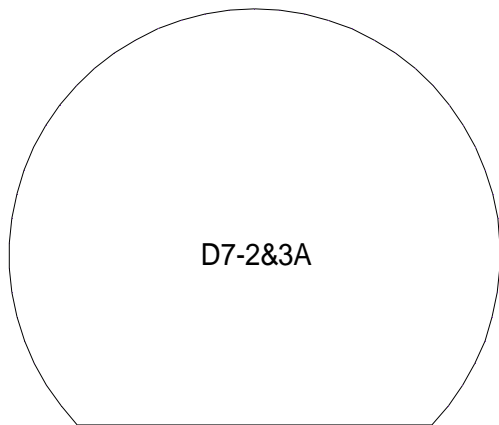
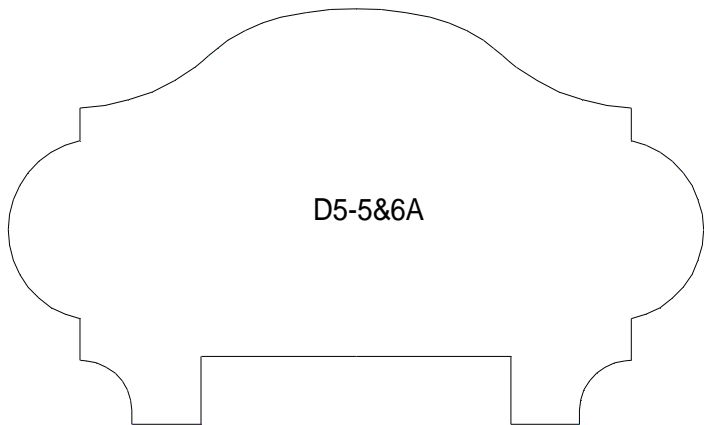

50mm



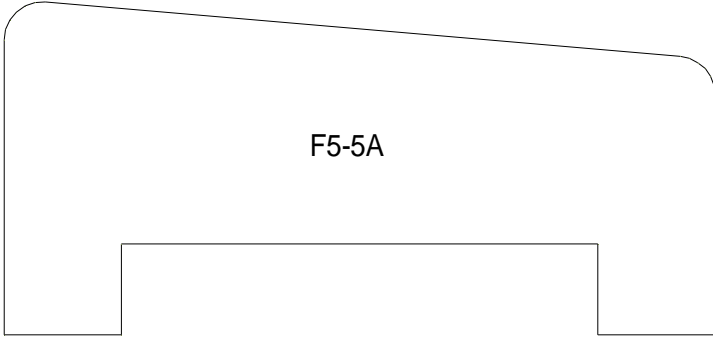
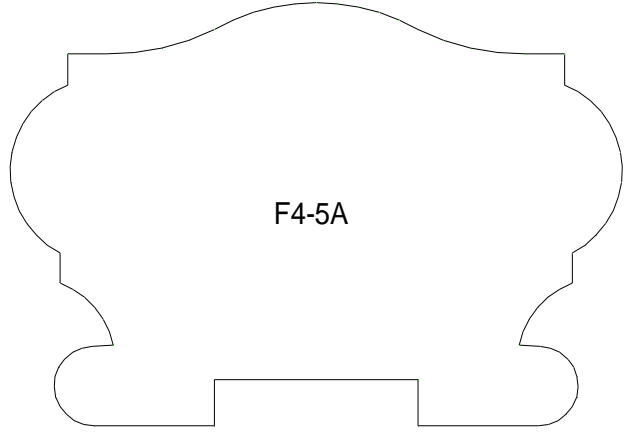
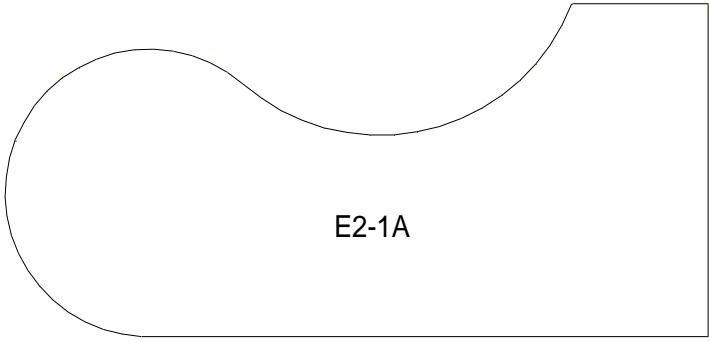

50mm



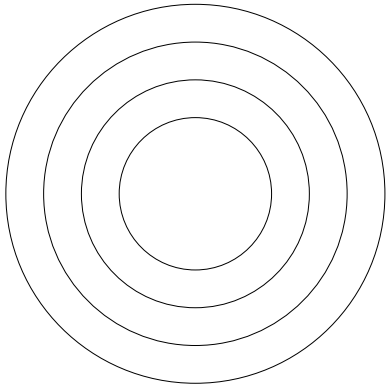

Various size Dowels

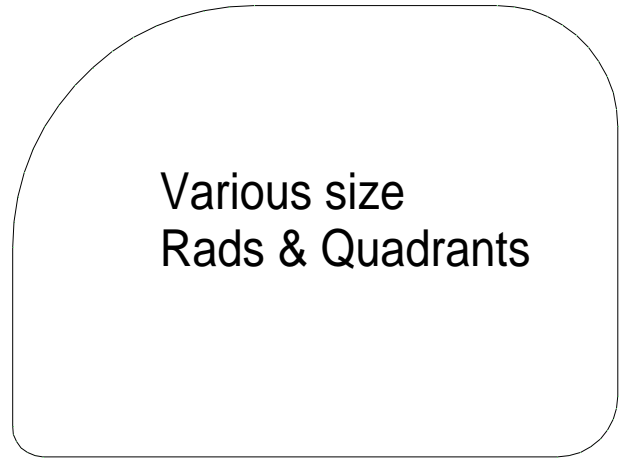

Various size  
Rads & Quadrants

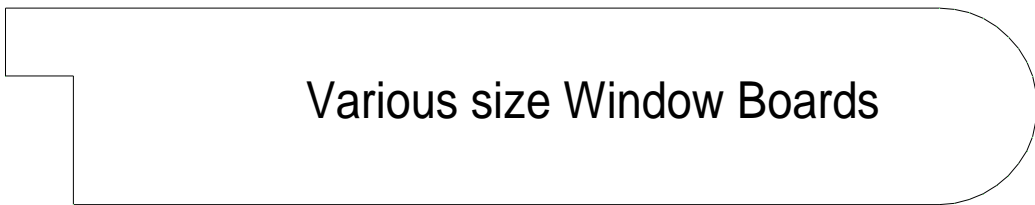

Various size Window Boards

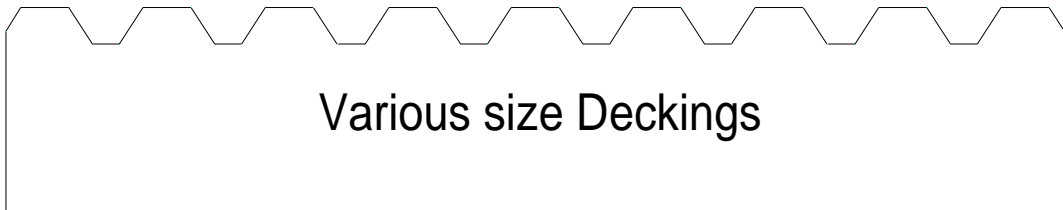

Various size Deckings



Various size Cills  
Flat And Stepped



Various size Claddings

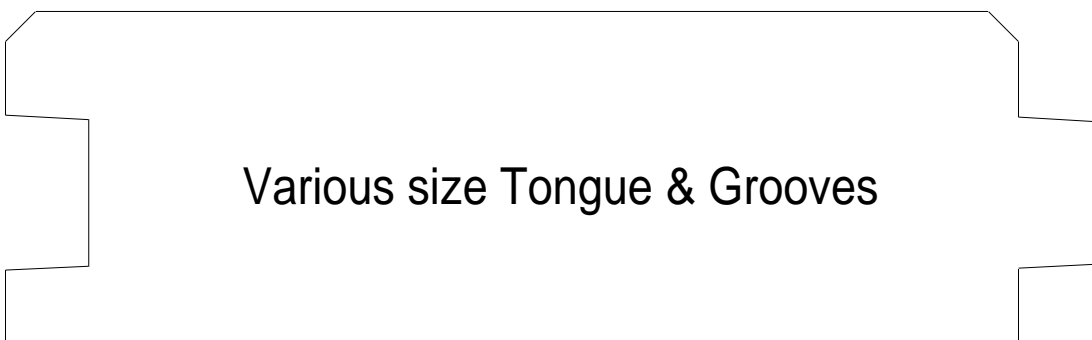

Various size Tongue & Grooves

50mm

